

# KÜCHENPROFI

## Katalog 2015/2016



Design | Funktion | Qualität



-  **4-11 Serie Provence**  
Gusseisen-Geschirr, WOK-Sets, Keramiktöpfchen usw.
-  **12-19 Servierkollektion**  
ofenfestes Hartporzellan und ofenfeste Keramik
-  **23-26 Pasta**  
original italienische Nudelmaschinen, Zubehör für Pasta
-  **27-28 Pizza**  
Zubehör für Pizza
-  **29-38 Pâtissier**  
Dekorierlöffel, Silikon-Set's, Ausstecher und weiteres Backzubehör
-  **39-48 Praktische Küchenhelfer**  
Brotkästen, Küchenwaagen, Abgießsiebe und andere nützliche Helfer
-  **49-51 Passieren und Einkochen**  
Trichter und Passiergeräte
-  **52-54 Schönes und Nützliches**  
Lunchboxen, Löffelablagen und Papierrollenhalter
-  **55-58 Würze und Co.**  
Mörser-Kollektion, Essig- und Ölsprüher, Muskatmühlen sowie Gemüseschäler
-  **59-60 Spargel**  
Zubehör für die Spargelzeit
-  **61-69 Reibenvielfalt**  
Reibenkollektion, Standreiben und Accessoires
-  **70-73 Timer und andere Helfer**  
Klassische-/ Digitaltimer und Sanduhren
-  **74-77 Braten**  
Braten-Zubehör und Thermometer
-  **78-84 Tee und Kaffee**  
mit unverzichtbarem Zubehör und dem Tea-Boy
-  **85-87 Praktische Küchenhelfer**  
Setzei-Ringe, Trocknerbälle, und Spülbürsten. Anspruchsvolles Genießen.
-  **88-95 Grillen**  
Unverzichtbares Zubehör
-  **96-102 Praktische Küchenhelfer**  
Gadgets, Siebe uvm.
-  **96-110 Salatschleudern und mehr**  
Salatschleudern, Kartoffel- und Spätzlepressen, Pommes Frites Schneider und Zitronenpressen
-  **111-116 Raclette, Fondue und Zubehör**  
das Beste zum Kochen auf dem Tisch
-  **117-118 Crème Brûlée Accessoires**  
für Einsteiger und Profis
-  **119-122 Kochgeschirr & Sonstiges**  
Töpfe und Bräter, Siebe, Seiher und Schüsseln
-  **123-127 Scheren und Schneidebretter**  
Geflügel, Kräuter und Co.
-  **128-135 Würzen und mehr**  
Gewürzständer, Salz- und Pfeffermühlen – manuell und elektrisch
-  **136-139 Werbemittel**
-  **140-145 Servicebereich**  
Außendienst & Inhaltsverzeichnis



# Die neue Guss-Kollektion

## Profi-Qualität

- optimale Hitzeverteilung
- besonders energiesparend
- ergonomisch geformte Griffe
- Deckelknöpfe hitzebeständig bis 250°C
- für besonders schonendes & schmackhaftes Braten und Garen
- Lieferung in einer attraktiven Geschenkbox
- entworfen in Kooperation mit: **TASSILO VON GROLMAN DESIGN**







■ Kompetentes Sortiment, zeitloses sowie eigenständiges Design, kompromisslose Qualität und Verarbeitung auf TOP-Niveau, einzigartiges Preis-Leistungs-Verhältnis...das ist „Provence“!!!

■ 30 Jahre Garantie

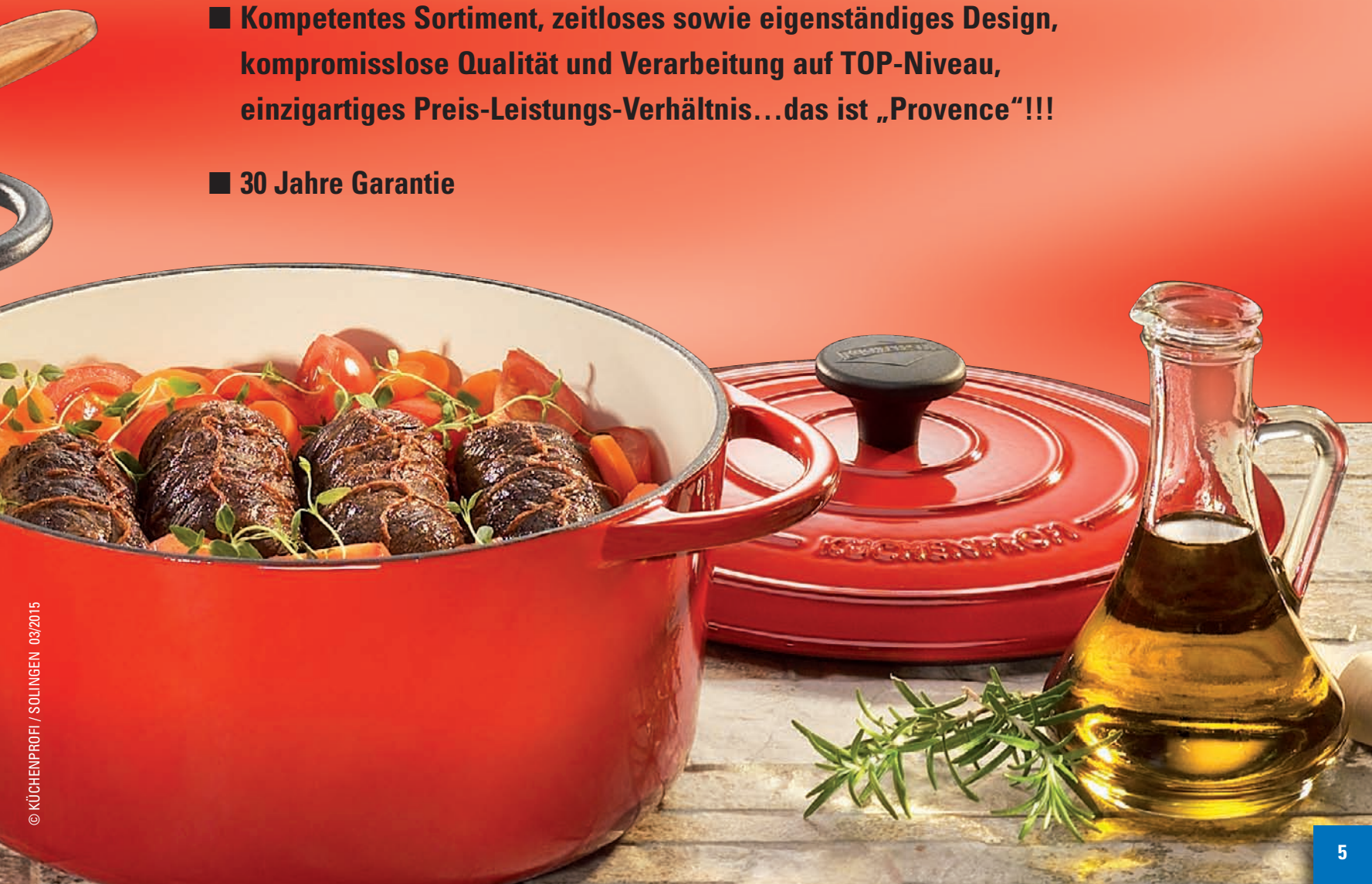

- für besonders schonendes & schmackhaftes Braten und Garen.
- Profi-Qualität
- optimale Hitzeverteilung ■ besonders energiesparend
- mit Plan-Boden für: Glaskeramik, Induktion, Halogen, Elektro, Gas

### Bratentopf, rund mit Gussdeckel, schwarz

round french oven, with lid  
cocotte ronde, avec couvercle  
casseruola rotonda, con coperchio  
cacerola redonda, con tapa  
kookpan rond, met deksel



Ø cm	Höhe cm	Inhalt ltr.	Ø inch	Art.-Nr.	EAN	GP
24,0	11,5	4,2	9½	04 0100 10 24	4 007371 056687	
26,0	12,0	5,3	10	04 0100 10 26	4 007371 056700	
28,0	13,0	6,6	11	04 0100 10 28	4 007371 060264	

### Bratentopf, oval mit Gussdeckel, schwarz

oval french oven, with lid  
cocotte ovale, avec couvercle  
casseruola ovale, con coperchio  
cacerola oval, con tapa  
kookpan ovaal, met deksel



Ø cm	Höhe cm	Inhalt ltr.	Ø inch	Art.-Nr.	EAN	GP
33,0	13,0	7,0	13	04 0200 10 33	4 007371 057530	
35,0	14,0	8,9	14	04 0200 10 35	4 007371 057554	
40,0	16,0	12,5	16	04 0200 10 40	4 007371 057578	

### Bauernpfanne mit hohem Glasdeckel, schwarz

braising pot, with glass lid  
cocotte, avec couvercle en verre  
casseruola, con coperchio in vetro  
cacerola, con tapa vidrio  
kookpan, met glasdeksel



Ø cm	Höhe cm	Inhalt ltr.	Ø inch	Art.-Nr.	EAN	GP
28,0	7,5	3,25	11	04 0255 10 28	4 007371 056724	

### Gourmetpfanne mit Gussdeckel, schwarz

braising pot, with lid  
cocotte, avec couvercle  
casseruola, con coperchio  
cacerola, con tapa  
kookpan, met deksel



Ø cm	Höhe cm	Inhalt ltr.	Ø inch	Art.-Nr.	EAN	GP
28,0	7,5	3,9	11	04 1600 10 28	4 007371 060288	

### Gourmetpfanne mit Glasdeckel, schwarz

braising pot, with glass lid  
cocotte, avec couvercle en verre  
casseruola, con coperchio in vetro  
cacerola, con tapa vidrio  
kookpan, met glasdeksel



Ø cm	Höhe cm	Inhalt ltr.	Ø inch	Art.-Nr.	EAN	GP
28,0	7,5	3,9	11	04 1700 10 28	4 007371 054065	







- für besonders schonendes & schmackhaftes Braten und Garen.
- Profi-Qualität
- optimale Hitzeverteilung ■ besonders energiesparend
- mit Plan-Boden für: Glaskeramik, Induktion, Halogen, Elektro, Gas



### Bratpfanne mit Edelstahlgriff, schwarz

fry pan with stainless steel handle  
poêle avec manche en acier inoxydable  
padella con manico in acciaio inox  
sartén con mango de acero inoxidable  
koekepan met edelstalen greep





cm	inch	Art.-Nr.	EAN	
24,0	9½	04 0300 10 24	4 007371 058896	
28,0	11	04 0300 10 28	4 007371 056748	

### Bratreine, schwarz

roasting pan  
braisière  
brasiera  
placa asar  
braadslede





L / B / H cm	Inhalt ltr.	inch	Art.-Nr.	EAN	
43,0 x 25,0 x 7,0	4,7	17 x 10 x 3	04 0400 10 43	4 007371 059343	

### Grillpfanne mit 2 Griffen, schwarz

grill pan with 2 handles  
poêle pour grillades avec 2 manches  
padella per arrosti con 2 manichi  
sartén para rustidos con 2 mangos  
grillpan met 2 grepen





Ø cm	Ø inch	Art.-Nr.	EAN	
26,0	10	04 0759 10 26	4 007371 059367	

Grill-/Bratfläche: 25,0 cm

### Grillpfanne mit Griff, schwarz

grill pan with handle  
poêle pour grillades avec manche  
padella per arrosti con manico  
sartén para rustidos con mango  
grillpan met greep





L / B / H cm	inch	Art.-Nr.	EAN	
26,0 x 26,0 x 4,5	10 x 10 x 2	04 0780 10 26	4 007371 059374	

Grill-/Bratfläche: 23,0 cm

### Grillpfanne quadratisch, schwarz

grill pan, square  
poêle pour grillades, carrée  
padella per arrosti, rettangolare  
sartén para rustidos, cuadrado  
grillpan vierkant



L / B cm	inch	Art.-Nr.	EAN	
24,0 x 24,0 x 1,5	9½ x 9½ x ½	04 0753 10 24	4 007371 060967	



Grill-/Bratfläche: 22,0 x 22,0 cm  
Griff klappbar



- für besonders schonendes & schmackhaftes Braten und Garen.
- Profi-Qualität
- optimale Hitzeverteilung ■ besonders energiesparend
- mit Plan-Boden für: Glaskeramik, Induktion, Halogen, Elektro, Gas





### Paella-Pfanne mit Glasdeckel, schwarz

Ø cm	Höhe cm	Inhalt ltr.	Ø inch	Art.-Nr.	EAN	
34,0	5,0	3,0	13 1/8	04 0600 10 34	4 007371 061100	

paella pan, with glass lid  
 poêle pour paella, avec couvercle en verre  
 padella per paella, con coperchio in vetro  
 paellera, con tapa vidrio  
 paella-pan, met glasdeksel



### Wok-Set mit Glasdeckel, inklusive Zubehör, schwarz

Ø cm	Höhe cm	Ø inch	Art.-Nr.	EAN	
36,0	9,5	14	04 1500 10 37	4 007371 054034	



(WOK-Wender und Chopsticks aus Naturholz, Abtropfgitter)

WOK set



## KÜCHENPROFI »Premium« Serie in ausgezeichnete Profi-Qualität

### WOK-Set mit Glasdeckel, Edelstahl-Design-Griffen, inklusive Zubehör, schwarz



Ø cm	Höhe cm	Ø inch	Art.-Nr.	EAN	
36,0	10,0	14	04 1000 10 36	4 007371 041621	

(WOK-Wender aus Naturholz, Abtropfgitter)

WOK set



### Gourmet-Pfanne mit Glasdeckel und Edelstahl-Design-Griffen, schwarz

Ø cm	Höhe cm	Inhalt ltr.	Ø inch	Art.-Nr.	EAN	
28,0	7,5	3,9	11	04 2000 10 28	4 007371 042338	

braising pot, with glass lid  
 cocotte, avec couvercle en verre  
 casseruola, con coperchio in vetro  
 cacerola, con tapa vidrio  
 kookpan, met glasdeksel







- für besonders schonendes & schmackhaftes Braten und Garen.
- Profi-Qualität
- optimale Hitzeverteilung ■ besonders energiesparend
- mit Plan-Boden für: Glaskeramik, Induktion, Halogen, Elektro, Gas



### Bratentopf, rund mit Gussdeckel, rot

round french oven, with lid  
 cocotte ronde, avec couvercle  
 casseruola rotonda, con coperchio  
 cacerola redonda, con tapa  
 kookpan rond, met deksel



Ø cm	Höhe cm	Inhalt ltr.	Ø inch	Art.-Nr.	EAN	
24,0	11,5	4,2	9½	04 0100 14 24	4 007371 056694	
26,0	12,0	5,3	10	04 0100 14 26	4 007371 056717	
28,0	13,0	6,6	11	04 0100 14 28	4 007371 060271	

### Bratentopf, oval mit Gussdeckel, rot

oval french oven, with lid  
 cocotte ovale, avec couvercle  
 casseruola ovale, con coperchio  
 cacerola oval, con tapa  
 kookpan ovaal, met deksel



Ø cm	Höhe cm	Inhalt ltr.	Ø inch	Art.-Nr.	EAN	
33,0	13,0	7,0	13	04 0200 14 33	4 007371 057547	
35,0	14,0	8,9	14	04 0200 14 35	4 007371 057561	
40,0	16,0	12,5	16	04 0200 14 40	4 007371 057585	

### Bauernpfanne mit hohem Glasdeckel, rot

braising pot, with glass lid  
 cocotte, avec couvercle en verre  
 casseruola, con coperchio in vetro  
 cacerola, con tapa vidrio  
 kookpan, met glasdeksel



Ø cm	Höhe cm	Inhalt ltr.	Ø inch	Art.-Nr.	EAN	
28,0	7,5	3,25	11	04 0255 14 28	4 007371 056731	

### Gourmetpfanne mit Gussdeckel, rot

braising pot, with lid  
 cocotte, avec couvercle  
 casseruola, con coperchio  
 cacerola, con tapa  
 kookpan, met deksel



Ø cm	Höhe cm	Inhalt ltr.	Ø inch	Art.-Nr.	EAN	
28,0	7,5	3,9	11	04 1600 14 28	4 007371 060295	

### Gourmetpfanne mit Glasdeckel, rot

braising pot, with glass lid  
 cocotte, avec couvercle en verre  
 casseruola, con coperchio in vetro  
 cacerola, con tapa vidrio  
 kookpan, met glasdeksel



Ø cm	Höhe cm	Inhalt ltr.	Ø inch	Art.-Nr.	EAN	
28,0	7,5	3,9	11	04 1700 14 28	4 007371 054072	



- für besonders schonendes & schmackhaftes Braten und Garen.
- Profi-Qualität
- optimale Hitzeverteilung ■ besonders energiesparend
- mit Plan-Boden für: Glaskeramik, Induktion, Halogen, Elektro, Gas



### Bratpfanne mit Edelstahlgriff, rot

fry pan with stainless steel handle  
poêle avec manche en acier inoxydable  
padella con manico in acciaio inox  
sartén con mango de acero inoxidable  
koekepan met edelstalen greep

Ø cm	Ø inch	Art.-Nr.	EAN	GP
24,0	9½	04 0300 14 24	4 007371 058902	
28,0	11	04 0300 14 28	4 007371 056755	



### Bratreine, rot

roasting pan  
braisière  
brasiera  
placa asar  
braadslede

L / B / H cm	Inhalt ltr.	inch	Art.-Nr.	EAN	GP
43,0 x 25,0 x 7,0	4,7	17 x 10 x 3	04 0400 14 43	4 007371 059350	



### Grillpfanne mit Griff, rot

grill pan with handle  
poêle pour grillades avec manche  
padella per arrostiti con manico  
sartén para rustidos con mango  
grillpan met greep

L / B / H cm	inch	Art.-Nr.	EAN	GP
26,0 x 26,0 x 4,5	10 x 10 x 2	04 0780 14 26	4 007371 059381	

Grill-/Bratfläche: 23,0 cm



### Wok-Set mit Glasdeckel, inklusive Zubehör, rot

(WOK-Wender und Chopsticks aus Naturholz, Abtropfgitter)

WOK set

Ø cm	Höhe cm	Ø inch	Art.-Nr.	EAN	GP
36,0	9,5	14	04 1500 14 37	4 007371 054041	



### Paella-Pfanne mit Glasdeckel, rot

paella pan, with glass lid  
poêle pour paella, avec couvercle en verre  
padella per paella, con coperchio in vetro  
paellera, con tapa vidrio  
paella-pan, met glasdeksel

Ø cm	Höhe cm	Inhalt ltr.	Ø inch	Art.-Nr.	EAN	GP
34,0	5,0	3,0	13½	04 0600 14 34	4 007371 061117	







- ideal für Backofen, Mikrowelle, Kühl- oder Gefrierschrank
- temperaturbeständig von -18°C bis +250°C
- kratz- und schnittfest dank glasierter Oberfläche
- spülmaschinenfest



**Mini-Töpfchen aus Keramik**

ceramic mini casserole  
 mini cocotte de céramique  
 casseruola piccola di ceramica  
 cacerola pequeña de cerámica  
 mini pan van keramiek

	Ø cm	Höhe cm	Inhalt ltr.	Ø inch	Art.-Nr.	EAN	GP
●	10	5	0,2	4	04 5100 10 10	4 007371 060653	
●	10	5	0,2	4	04 5100 14 10	4 007371 060660	



Ofenfestes Hartporzellan

## Burgund

Profi-Qualität bekannt aus der Gastronomie, jetzt auch für den Gebrauch zu Hause  
 Das elegante Design der Formen und das schlichte Weiß bereichern jede Küche und den gedeckten Tisch. Jedes Teil wird bei ca. 1400° C gebrannt und erhält dadurch eine einzigartige Qualität.

- hitzebeständig bis 280°C
- stoßfest und kantenstabil
- geschmacksneutral
- hygienisch einwandfrei

Hervorragend für Backofen, Mikrowelle und Tiefkühlschrank geeignet.

bis 280°C  
 hitzebeständig  
 Gastronomie  
 erprobt





- für Backofen (bis 280°C)  
Mikrowelle, Kühlschrank und Gefrierschrank
- ideal zum Zubereiten, Servieren, Aufbewahren,  
Warmhalten und Einfrieren



### Bauernform, oval

deep baker  
plat à four  
pirofila  
fuente para horno  
ovenschaal

L/B/H cm	inch	Art.-Nr.	EAN
20,5 x 14,5 x 5,0	8 x 5½ x 2	07 5001 82 20	4 007371 050968
26,0 x 18,0 x 6,0	10 x 7 x 2½	07 5001 82 26	4 007371 049108
30,0 x 20,0 x 6,0	12 x 8 x 2½	07 5001 82 30	4 007371 046732
35,0 x 23,0 x 6,0	13½ x 9 x 2½	07 5001 82 35	4 007371 046749



### Auflaufform, rechteckig

deep baker  
moule à gratin  
teglia forno  
fuente  
gratineerschaal

L/B/H cm	inch	Art.-Nr.	EAN
12,5 x 8,0 x 3,5	5 x 3 x 1½	07 5011 82 12	4 007371 055529

24 Stück im attraktiven Verkaufs-Display



### Auflaufform, rechteckig

deep baker  
moule à gratin  
teglia forno  
fuente  
gratineerschaal

L/B/H cm	inch	Art.-Nr.	EAN
20,0 x 12,0 x 6,0	8 x 5 x 2½	07 5011 82 20	4 007371 050951
30,0 x 21,0 x 6,0	12 x 8½ x 2½	07 5011 82 30	4 007371 046756
35,0 x 24,0 x 6,0	13½ x 9½ x 2½	07 5011 82 35	4 007371 046763



### Lasagneform, extra hoch

deep baker  
moule à gratin  
teglia forno  
fuente  
gratineerschaal

L/B/H cm	inch	Art.-Nr.	EAN
24,0 x 15,0 x 6,5	9.5 x 6 x 2.5	07 5021 82 24	4 007371 060301
33,0 x 25,0 x 7,0	13 x 10 x 3	07 5021 82 33	4 007371 047838
38,0 x 25,0 x 7,0	15 x 10 x 3	07 5021 82 38	4 007371 047845



### Schlemmerform

deep baker  
moule à gratin  
teglia forno  
fuente  
gratineerschaal

L/B/H cm	inch	Art.-Nr.	EAN
31,0 x 21,0 x 5,5	12 x 8 x 2	07 5031 82 31	4 007371 049115
35,5 x 25,5 x 5,5	14 x 10 x 2	07 5031 82 35	4 007371 048682
41,0 x 30,5 x 5,5	16 x 12 x 2	07 5031 82 42	4 007371 048699



### Mikrowellenform

microwave dish  
moule à microonde  
pirofila per microonde  
fuente para microondas  
magnetronschaal

L/B/H cm	inch	Art.-Nr.	EAN
20,0 x 20,0 x 4,5	7¾ x 7¾ x 2	07 5151 82 20	4 007371 050630



- für Backofen (bis 280°C)  
Mikrowelle, Kühlschrank und Gefrierschrank
- ideal zum Zubereiten, Servieren, Aufbewahren,  
Warmhalten und Einfrieren



### Tartelettförmchen

round flan dish  
moule à tartelette  
stampo torta  
molde de tarta  
taartvorm



Ø cm	Höhe cm	Ø inch	Art.-Nr.	EAN
12,0	3,0	5	07 5041 82 12	4 007371 049009

24 Stück im attraktiven Verkaufs-Display

### Tortenform

round flan dish  
moule à tarte  
stampo torta  
molde de tarta  
taartvorm



Ø cm	Höhe cm	Ø inch	Art.-Nr.	EAN
20,0	3,5	8	07 5041 82 20	4 007371 057875
27,0	3,5	10½	07 5041 82 28	4 007371 048637
29,5	3,5	11½	07 5041 82 30	4 007371 048644
33,0	3,5	13	07 5041 82 33	4 007371 057882

### Ragoutschälchen

ramekin  
ramequin  
ramequin  
ramekin  
ragoutschaaltje



Ø cm	Höhe cm	Ø inch	Art.-Nr.	EAN
9,0	4,0	3½	07 5061 82 09	4 007371 048996

24 Stück im attraktiven Verkaufs-Display

11,0	5,5	4½	07 5061 82 11	4 007371 050944
------	-----	----	---------------	-----------------

12 Stück im attraktiven Verkaufs-Display

### Puddingförmchen

pudding bowl  
moule à clafoutis  
stampo budino  
ramekin  
puddingvorm



Ø cm	Höhe cm	Ø inch	Art.-Nr.	EAN
11,0	4,0	4½	07 5071 82 11	4 007371 049016

24 Stück im attraktiven Verkaufs-Display

### Eierbecher

egg cup  
coquetier  
portauovo  
huevera  
eierdopje



Ø cm	Höhe cm	Ø inch	Art.-Nr.	EAN
5,0	7,0	2	07 5081 82 00	4 007371 049054

24 Stück im attraktiven Verkaufs-Display

### Eierbecher, 2er Set

egg cup  
coquetier  
portauovo  
huevera  
eierdopje



Ø cm	Ø inch	Art.-Nr.	EAN
10,5	4	07 5082 82 02	4 007371 053167



GP = Produkt in farbigem Geschenkkarton



KE = auf Karte mit Euroloch

- für Backofen (bis 280°C)  
Mikrowelle, Kühlschrank und Gefrierschrank
- ideal zum Zubereiten, Servieren, Aufbewahren,  
Warmhalten und Einfrieren



### Ragoutschälchen »Classic«

ramekin  
ramequin  
ramequin  
ramekin  
ragoutschaaltje



Ø cm	Höhe cm	Ø inch	Art.-Nr.	EAN
9,0	4,0	3½	07 5404 82 09	4 007371 048989

24 Stück im attraktiven Verkaufs-Display

### Crème Brûlée-Schale »Classic«

Crème Brûlée dish  
moule à Crème Brûlée  
scodella Crème Brûlée  
bol para crema catalana  
Crème Brûlée schaalte



Ø cm	Höhe cm	Ø inch	Art.-Nr.	EAN
15,0	2,5	6	07 2050 82 00	4 007371 051132

### Crème Brûlée-Schale

Crème Brûlée dish  
moule à Crème Brûlée  
scodella Crème Brûlée  
bol para crema catalana  
Crème Brûlée schaalte



Ø cm	Höhe cm	Ø inch	Art.-Nr.	EAN
15,0	2,5	6	07 5091 82 15	4 007371 049061

### Mini Terrinenformen, 3er Set

mini tureen dish  
mini terrine  
mini terrina  
molde para paté  
mini terrine vorm



Ø cm	Höhe cm	Ø inch	Art.-Nr.	EAN
10,0	3,5	3½	07 5010 82 03	4 007371 057899

Hase, Fisch und Ente - Inhalt je 100ml

### Zitronenpresse

lemon squeezer  
presse-agrumes  
spremiagrumi  
prensa limones  
citruspers



L / B / H cm	inch	Art.-Nr.	EAN
20,0 x 11,0 x 5,5	8 x 4 x 2	07 6060 82 00	4 007371 054195

### Pastetenform

pie dish  
terrines à pâté  
terrina  
terrina  
terrines



L / B / H cm	Inhalt ltr.	inch	Art.-Nr.	EAN
19,0 x 14,5 x 8,5	1,0	7½ x 6 x 3½	07 4303 82 10	4 007371 060615
24,0 x 17,5 x 9,0	1,6	9½ x 7 x 3½	07 4303 82 16	4 007371 060622



## die farbenfrohe Servierkollektion

aus ofenfester Keramik, französische Produktion

- für Backofen (bis 280°C)  
Mikrowelle und Kühlschrank
- ideal zum Zubereiten, Servieren und Aufbewahren

**Auflaufform,  
mandarine/orange**

deep baker  
plat à pâté  
teglia forno  
fuente  
gratineerschaal

L/B/H cm	inch	Art.-Nr.	EAN
33,0 x 22,5 x 6,0	13 x 9 x 2½	<b>07 0500 40 33</b>	4 007371 054645

**Auflaufform,  
cremeweiß/anthrazit**

deep baker  
plat à pâté  
teglia forno  
fuente  
gratineerschaal

L/B/H cm	inch	Art.-Nr.	EAN
33,0 x 22,5 x 6,0	13 x 9 x 2½	<b>07 0500 41 33</b>	4 007371 054652

**Auflaufform,  
kiwi/mirabelle**

deep baker  
plat à pâté  
teglia forno  
fuente  
gratineerschaal

L/B/H cm	inch	Art.-Nr.	EAN
33,0 x 22,5 x 6,0	13 x 9 x 2½	<b>07 0500 42 33</b>	4 007371 054669

**Auflaufform,  
meerblau/creme**

deep baker  
plat à pâté  
teglia forno  
fuente  
gratineerschaal

L/B/H cm	inch	Art.-Nr.	EAN
33,0 x 22,5 x 6,0	13 x 9 x 2½	<b>07 0500 43 33</b>	4 007371 054676

**Auflaufform,  
schwarz/rot**

deep baker  
plat à pâté  
teglia forno  
fuente  
gratineerschaal

L/B/H cm	inch	Art.-Nr.	EAN
33,0 x 22,5 x 6,0	13 x 9 x 2½	<b>07 0500 44 33</b>	4 007371 054683

**Auflaufform,  
pflaume/malve**

deep baker  
plat à pâté  
teglia forno  
fuente  
gratineerschaal

L/B/H cm	inch	Art.-Nr.	EAN
33,0 x 22,5 x 6,0	13 x 9 x 2½	<b>07 0500 45 33</b>	4 007371 054690

- für Backofen (bis 280°C)  
Mikrowelle und Kühlschrank
- ideal zum Zubereiten, Servieren und Aufbewahren



**Lasagneform,  
mandarine/orange**

deep baker  
moule à lasagne  
teglia forno  
fuente  
gratineerschaal

L/B/H cm	inch	Art.-Nr.	EAN
28,0 x 19,5 x 6,5	11 x 7½ x 2½	<b>07 0600 40 28</b>	4 007371 055123



**Lasagneform,  
cremeweiß/anthrazit**

deep baker  
moule à lasagne  
teglia forno  
fuente  
gratineerschaal

L/B/H cm	inch	Art.-Nr.	EAN
28,0 x 19,5 x 6,5	11 x 7½ x 2½	<b>07 0600 41 28</b>	4 007371 055130



**Lasagneform,  
kiwi/mirabelle**

deep baker  
moule à lasagne  
teglia forno  
fuente  
gratineerschaal

L/B/H cm	inch	Art.-Nr.	EAN
28,0 x 19,5 x 6,5	11 x 7½ x 2½	<b>07 0600 42 28</b>	4 007371 055147



**Lasagneform,  
meerblau/creme**

deep baker  
moule à lasagne  
teglia forno  
fuente  
gratineerschaal

L/B/H cm	inch	Art.-Nr.	EAN
28,0 x 19,5 x 6,5	11 x 7½ x 2½	<b>07 0600 43 28</b>	4 007371 055154



**Lasagneform,  
schwarz/rot**

deep baker  
moule à lasagne  
teglia forno  
fuente  
gratineerschaal

L/B/H cm	inch	Art.-Nr.	EAN
28,0 x 19,5 x 6,5	11 x 7½ x 2½	<b>07 0600 44 28</b>	4 007371 055161



**Lasagneform,  
pflaume/malve**

deep baker  
moule à lasagne  
teglia forno  
fuente  
gratineerschaal

L/B/H cm	inch	Art.-Nr.	EAN
28,0 x 19,5 x 6,5	11 x 7½ x 2½	<b>07 0600 45 28</b>	4 007371 055178



# die farbenfrohe Servierkollektion

aus ofenfester Keramik, französische Produktion

- für Backofen (bis 280°C)  
Mikrowelle und Kühlschrank
- ideal zum Zubereiten, Servieren und Aufbewahren



## Ragoutschälchen, 4er Set mandarine/orange

ramekin  
ramequin  
ramequin  
ramekin  
ragoutschaaltje

Ø cm	Höhe cm	Ø inch	Art.-Nr.	EAN
10,0	4,5	4	07 0700 40 04	4 007371 055185



## Ragoutschälchen, 4er Set cremeweiß/anthrazit

ramekin  
ramequin  
ramequin  
ramekin  
ragoutschaaltje

Ø cm	Höhe cm	Ø inch	Art.-Nr.	EAN
10,0	4,5	4	07 0700 41 04	4 007371 055192



## Ragoutschälchen, 4er Set kiwi/mirabelle

ramekin  
ramequin  
ramequin  
ramekin  
ragoutschaaltje

Ø cm	Höhe cm	Ø inch	Art.-Nr.	EAN
10,0	4,5	4	07 0700 42 04	4 007371 055208



## Ragoutschälchen, 4er Set meerblau/creme

ramekin  
ramequin  
ramequin  
ramekin  
ragoutschaaltje

Ø cm	Höhe cm	Ø inch	Art.-Nr.	EAN
10,0	4,5	4	07 0700 43 04	4 007371 055215



## Ragoutschälchen, 4er Set schwarz/rot

ramekin  
ramequin  
ramequin  
ramekin  
ragoutschaaltje

Ø cm	Höhe cm	Ø inch	Art.-Nr.	EAN
10,0	4,5	4	07 0700 44 04	4 007371 055222



## Ragoutschälchen, 4er Set pflaume/malve

ramekin  
ramequin  
ramequin  
ramekin  
ragoutschaaltje

Ø cm	Höhe cm	Ø inch	Art.-Nr.	EAN
10,0	4,5	4	07 0700 45 04	4 007371 055239



**Tortenform, mandarine/orange**

round flan dish  
moule à tarte  
stampo torta  
molde de tarta  
taartvorm



Ø cm	Höhe cm	Ø inch	Art.-Nr.	EAN
28,0	4,0	11	<b>07 0800 40 28</b>	4 007371 055246

**Tortenform, cremeweiß/anthrazit**

round flan dish  
moule à tarte  
stampo torta  
molde de tarta  
taartvorm



Ø cm	Höhe cm	Ø inch	Art.-Nr.	EAN
28,0	4,0	11	<b>07 0800 41 28</b>	4 007371 055253

**Tortenform, kiwi/mirabelle**

round flan dish  
moule à tarte  
stampo torta  
molde de tarta  
taartvorm



Ø cm	Höhe cm	Ø inch	Art.-Nr.	EAN
28,0	4,0	11	<b>07 0800 42 28</b>	4 007371 055260

**Tortenform, meerblau/creme**

round flan dish  
moule à tarte  
stampo torta  
molde de tarta  
taartvorm



Ø cm	Höhe cm	Ø inch	Art.-Nr.	EAN
28,0	4,0	11	<b>07 0800 43 28</b>	4 007371 055277

**Tortenform, schwarz/rot**

round flan dish  
moule à tarte  
stampo torta  
molde de tarta  
taartvorm



Ø cm	Höhe cm	Ø inch	Art.-Nr.	EAN
28,0	4,0	11	<b>07 0800 44 28</b>	4 007371 055284

**Tortenform, pflaume/malve**

round flan dish  
moule à tarte  
stampo torta  
molde de tarta  
taartvorm



Ø cm	Höhe cm	Ø inch	Art.-Nr.	EAN
28,0	4,0	11	<b>07 0800 45 28</b>	4 007371 055291



Alles für

# italienische Pizza und Pasta

Die original italienischen Nudelmachines von Marcato gehören zu den unentbehrlichen Helfern für perfekte Pasta.

Mit dem praktischen Zubehör gelangen Ihnen mühelos kulinarische Köstlichkeiten für einen unverwechselbaren Genuss bei Ihnen zu Hause.







**Nudelmaschine  
»Ampia«  
mit 3 Aluminium-Walzen**

pasta machine  
machine à nouilles  
macchina per pasta  
máquina pastas  
pastamachine

Art.-Nr. EAN   
**08 0150 12 15** 8 0000 11 0000 3 9

L/B/H cm inch  
20,0 x 17,0 x 13,0 8 x 6½ x 5

nicht kompatibel mit den Marcato-Vorsätzen  
geeignet für Lasagne, Fettuccine & Tagliolini  
geeignet für Motor



**Nudelmaschine  
»Atlas 150«  
mit 3 Aluminium-Walzen**

pasta machine  
machine à nouilles  
macchina per pasta  
máquina pastas  
pastamachine

Art.-Nr. EAN   
**08 0151 12 00** 8 0000 11 0020 5 7

L/B/H cm inch  
19,0 x 12,4 x 13,0 7½ x 5 x 5

geeignet für Lasagne, Fettuccine & Tagliolini  
geeignet für Motor



**Nudelmaschine  
»Multipast«  
mit 6 Aluminium-Walzen**

pasta machine  
machine à nouilles  
macchina per pasta  
máquina pastas  
pastamachine

Art.-Nr. EAN   
**08 0153 12 00** 8 0000 11 000 17 6

Set besteht aus:  
- Nudelmaschine ATLAS, geeignet für  
Lasagne, Fettuccine & Tagliolini  
- Aufsätze für Raviolini, Spaghetti und  
Reginette sowie einem Teigrädchen  
geeignet für Motor



**Nudelmaschine  
»Atlasmotor«  
mit 3 Aluminium-Walzen  
und Motor**

pasta machine  
machine à nouilles  
macchina per pasta  
máquina pastas  
pastamachine

Art.-Nr. EAN   
**08 0155 12 00** 8 0000 11 0020 7 1

geeignet für  
Lasagne, Fettuccine & Tagliolini  
Set besteht aus:  
- Nudelmaschine ATLAS, geeignet für  
Lasagne, Fettuccine & Tagliolini  
- Motor, 230V ~ 50Hz, 100 Watt, Gehäuse aus  
Kunststoff



**Profi-Nudelmaschine  
»Ristorantica«**

prof. pasta machine  
machine à nouilles professionnelle  
macchina per pasta professionale  
máquina pastas profesional  
professioneela pastamachine

Art.-Nr. EAN   
**08 0185 00 00** 8 0000 11 0040 0 6

L/B/H cm inch  
35,0 x 25,0 x 29,0 13½ x 10 x 11½

Aluminium eloxiert  
Grundausrüstung: Maschine, 2 Aufsätze  
(Lasagne, Fettuccine), 3 Schablonen (Spaghetti,  
Rigatoni, Maccheroni), Teigschneider  
technische Daten: 220-240 Volt / 700 Watt





**Nudelmaschine  
»Atlas 150«**

pasta machine  
machine à nouilles  
macchina per pasta  
máquina pastas  
pastamachine

schwarz

Art.-Nr.	EAN	
08 0163 10 00	8 000011 002491	

L/B/H cm	inch
19,0 x 12,4 x 13,0	8 x 6½ x 5

geeignet für Lasagne, Fettuccine & Tagliolini  
geeignet für Motor



**Nudelmaschine  
»Atlas 150«**

pasta machine  
machine à nouilles  
macchina per pasta  
máquina pastas  
pastamachine

rot

Art.-Nr.	EAN	
08 0163 14 00	8 000011 002477	

L/B/H cm	inch
19,0 x 12,4 x 13,0	7½ x 5 x 5

geeignet für Lasagne, Fettuccine & Tagliolini  
geeignet für Motor



**Nudelmaschine  
»Atlas 150«**

pasta machine  
machine à nouilles  
macchina per pasta  
máquina pastas  
pastamachine

silber

Art.-Nr.	EAN	
08 0163 24 00	8 000011 002606	

L/B/H cm	inch
19,0 x 12,4 x 13,0	7½ x 5 x 5

geeignet für Lasagne, Fettuccine & Tagliolini  
geeignet für Motor



GP = Produkt in farbigem Geschenkkarton



KE = auf Karte mit Euroloch



**Aufsätze / Zubehör  
für die Nudelmaschine »ATLAS«  
Walzen aus eloxiertem Aluminium**



**Motor für  
Nudelmaschine**

motor for pasta machine  
moteur pour machine à nouilles  
motore per macchina per pasta  
motor para máquina pastas  
motor voor pastamachine

L/B/H cm	inch	Art.-Nr.	EAN	GP
18,0 x 14,0 x 11,0	7 x 5½ x 4¼	08 0150 00 01	8 0000 11 0020 33	

Technische Daten: Betriebsspannung: 230V ~ 50Hz,  
Motorleistung: 100 Watt

Gehäuse aus Kunststoff



**Lasagnette-Aufsatz**

attachment for lasagnette  
adaptateur pour pâtes lasagnette  
accessorio per lasagnette  
acessorio para lasagnette  
opzet voor lasagnette

L/B/H cm	inch	Art.-Nr.	EAN	GP
18,0 x 7,0 x 4,0	7 x 2½ x 1½	08 0150 00 03	8 0000 11 0020 26	

Breite der Pasta 11 mm  
geeignet für Motor



**Mafaldine-Aufsatz**

attachment for mafaldine  
adaptateur pour pâtes mafaldine  
accessorio per mafaldine  
acessorio para mafaldine  
opzet voor mafaldine

L/B/H cm	inch	Art.-Nr.	EAN	GP
18,0 x 7,0 x 5,0	7 x 2½ x 2	08 0150 00 04	8 0000 11 0004 23	

Breite der Pasta 8 mm



**Pappardelle-Aufsatz**

attachment for pappardelle  
adaptateur pour pâtes pappardelle  
accessorio per pappardelle  
acessorio para pappardelle  
opzet voor pappardelle

L/B/H cm	inch	Art.-Nr.	EAN	GP
18,0 x 7,0 x 5,0	7 x 2½ x 2	08 0150 00 05	8 0000 11 0001 33	

Breite der Pasta 50 mm



**Raviolini-Aufsatz**

attachment for raviolini  
adaptateur pour pâtes raviolini  
accessorio per raviolini  
acessorio para raviolini  
opzet voor raviolini

L/B/H cm	inch	Art.-Nr.	EAN	GP
18,0 x 11,0 x 10,0	7 x 4¼ x 4	08 0150 00 06	8 0000 11 0021 49	

Breite der Pasta 30 x 30 mm  
mit Trichter für die Füllung



**Reginette-Aufsatz**

attachment for reginette  
adaptateur pour pâtes reginette  
accessorio per reginette  
acessorio para reginette  
opzet voor reginette

L/B/H cm	inch	Art.-Nr.	EAN	GP
18,0 x 7,0 x 5,0	7 x 2½ x 2	08 0150 00 07	8 0000 11 0001 27	

Breite der Pasta 12 mm



**Chitarra-Aufsatz**

attachment for chitarra  
adaptateur pour pâtes chitarra  
accessorio per chitarra  
acessorio para chitarra  
opzet voor chitarra

L/B/H cm	inch	Art.-Nr.	EAN	GP
18,0 x 7,0 x 5,0	7 x 2½ x 2	08 0150 00 08	8 0000 11 0001 07	

Breite der Pasta 2 mm  
für Spaghetti alla Chitarra  
geeignet für Motor





**Aufsätze / Zubehör  
für die Nudelmaschine »ATLAS«  
Walzen aus eloxiertem Aluminium**



**Capellini-Aufsatz**

attachment for capellini  
adaptateur pour pâtes capellini  
accessorio per capellini  
accessorio para capellini  
opzegt voor capellini

L/B/H cm	inch	Art.-Nr.	EAN	GP
18,0 x 7,0 x 4,0	7 x 2½ x 1½	08 0150 00 09	8 000011 000091	

Breite der Pasta 1 mm  
geeignet für Motor



**Spaghetti-Aufsatz**

attachment for spaghetti  
adaptateur pour spaghetti  
accessorio per spaghetti  
accessorio para spaghetti  
spaghetti opzet

L/B/H cm	inch	Art.-Nr.	EAN	GP
18,0 x 7,0 x 5,0	7 x 2½ x 2	08 0150 00 10	8 000011 000084	

Breite der Pasta 2 mm  
für Spaghetti  
geeignet für Motor 08 0150 00 01



**Ravioli-Aufsatz**

attachment for ravioli  
adaptateur pour raviolis  
accessorio per ravioli  
accessorio para ravioli  
ravioli opzet

L/B/H cm	inch	Art.-Nr.	EAN	GP
33,0 x 22,5 x 6,0	13 x 9 x 2½	07 0500 40 33	8 000011 002125	



**Nudelrockner  
»Tacapasta«**

pasta drying stand  
sècheoir à nouilles  
essiccatoio per pasta  
secadero para pastas  
pastadroger

L/B/H cm	inch	Art.-Nr.	EAN	GP
33,0 x 22,5 x 6,0	13 x 9 x 2½	07 0500 40 33	8 000011 003009	



**Nudelmaschine  
»Compack«**

pasta machine  
machine à nouilles  
macchina per pasta  
máquina pastas  
pastmaschine

L/B/H cm	inch	Art.-Nr.	EAN	GP
19,0 x 12,5 x 13,0	7½ x 5 x 5	08 0157 12 00	4 007371 048880	

geeignet für Lasagne, Fettuccine & Tagliolini



**Nudelmaschine  
»Compack«**

pasta machine  
machine à nouilles  
macchina per pasta  
máquina pastas  
pastmaschine

L/B/H cm	inch	Art.-Nr.	EAN	GP
19,0 x 12,5 x 13,0	7½ x 5 x 5	08 0157 14 00	4 007371 059299	

geeignet für Lasagne, Fettuccine & Tagliolini



# Pasta-Zubehör

Edelstahl rostfrei / stainless steel

## Raviolibrett

ravioli mould  
planche à raviolis  
accessorio raviolatore  
aparato antepusto ravioli  
raviolivorm met roller



L/B cm	inch	Art.-Nr.	EAN	
37,5 x 12,0	14¾ x 4¾	08 0290 30 12	4 007371 057011	

aus Aluminium, inklusive Holzrolle, für 12 Ravioli

## Ravioli-Rad

ravioli cutter  
roulette à raviolis  
tagliaravioli  
corta ravioli  
ravioli-snijder



Länge cm	inch	Art.-Nr.	EAN	
18,0	7	08 0350 28 00	4 007371 042796	

## Ravioli-Former, rund

ravioli mould  
moule à raviolis  
forma per ravioli  
molde para ravioli  
ravioli-vormer



Ø cm	Ø inch	Art.-Nr.	EAN	
10,0	4	08 0355 28 00	4 007371 045612	
12,0	4½	08 0360 28 00	4 007371 042932	

## Ravioliausstecher

ravioli stamp  
emporte pièce pour raviolis  
stampa per ravioli  
cortador de ravioli  
ravioli-steekvorm



Ø cm	Länge cm	Ø inch	Art.-Nr.	EAN	
6,5	12,5	2½	08 0371 28 00	4 007371 048651	

## Spaghetti-Maß »Classic«

spaghetti measure  
mesure à spaghetti  
misura spaghetti  
medidor spaghetti  
spaghettimaat



L/B cm	inch	Art.-Nr.	EAN	
18,0 x 6,0	7 x 2½	10 3450 28 00	4 007371 035279	

für 1 – 4 Portionen



# Pasta-Zubehör

Edelstahl rostfrei / stainless steel

Pasta & Pizza





**Spätzle-ASS**

spaetzle lid  
couvercle à spaetzle  
coperchio gnocchetti  
tapa formapastas  
spätzle-deksel

Ø cm	Ø inch	Art.-Nr.	EAN
27,0	10½	<b>08 0816 28 27</b>	4 007371 039840

für alle Töpfe von Ø 20 bis 28 cm, inklusive Teigschaber







**Spätzlereibe**

spaetzle maker  
couvercle à spaetzle  
coperchio gnocchetti  
tapa formapasta  
spätzle deksel

L/B/H cm	inch	Art.-Nr.	EAN
34,5 x 15,0 x 3,5	13½ x 6 x 1½	<b>08 0818 28 00</b>	4 007371 060080

Reibfläche 14 x 10 cm  
für alle Töpfe von Ø 20 bis 28 cm, inklusive Teigschaber  
hitzebeständige Griffe





**Spätzle-Hobel**

spaetzle plane  
râpe à spaetzle  
macchina gnocchetti inox  
dispositivo-formapastas  
spätzle-schaaf

L/B cm	inch	Art.-Nr.	EAN
31,0 x 11,0	12 x 4½	<b>10 0231 28 00</b>	4 007371 027991



**Schaumlöffel**

skimmer  
écumoire  
schiumarola  
espumadera  
schuimspaan

L cm	Ø cm Kelle	inch	Art.-Nr.	EAN
41,0	14	16 x 5½	<b>11 0548 28 00</b>	4 007371 057370



**Kartoffel-/Spätzlepresse**

potato / spaetzle press  
presse purée / spaetzle  
schiacciapate / -gnocchetti  
prensa patatas /pasta fresca  
puree- /spätzlepers

Ø cm	Länge cm	Ø inch	Art.-Nr.	EAN
8,0	37,0	3	<b>13 1056 28 00</b>	4 007371 041409



**Kartoffel-/Spätzlepresse  
»Spätzleboy«**

potato / spaetzle press  
presse purée / spaetzle  
schiacciapate / -gnocchetti  
prensa patatas /pasta fresca  
puree- /spätzlepers

Ø cm	Länge cm	Ø inch	Art.-Nr.	EAN
9,0	42,0	3½	<b>13 1075 30 00</b>	4 007371 056359

Aluminium-Guss  
auch für Spaghetti-Eis geeignet

GP = Produkt in farbigem Geschenkkarton

KE = auf Karte mit Euroloch

Alles für

# Pizza

Steinofenpizza wie vom Lieblings-Italiener gelingt jetzt auch zu Hause. Die hochhitzebeständigen Pizza- und Grillsteine garantieren knusprigen Boden. Auch die Zubereitung anderer Spezialitäten im Backofen oder auf dem Grill wird zum Kinderspiel.



# Pizzasteine und Zubehör



## Pizza-Stein, mit Untersatz

pizza stone  
pierre à pizza  
pietra per pizza  
base para hornear pizza  
pizzasteen

L/B cm	inch	Art.-Nr.	EAN
38,0 x 35,5	15 x 14	10 8600 00 00	4 007371 049368

aus Cordierit-Material  
ideal für die Zubereitung knuspriger Steinofenpizza



## Pizza-Stein, mit Untersatz

pizza stone  
pierre à pizza  
pietra per pizza  
base para hornear pizza  
pizzasteen

Ø cm	Ø inch	Art.-Nr.	EAN
30,0	12	10 8610 00 30	4 007371 055741

aus Cordierit-Material  
ideal für die Zubereitung knuspriger Steinofenpizza



## Pizza-Stein »Profi«

pizza stone  
pierre à pizza  
pietra per pizza  
base para hornear pizza  
pizzasteen

L/B cm	inch	Art.-Nr.	EAN
35,0 x 40,0	14 x 16	10 8615 00 40	4 007371 055758

aus Cordierit-Material  
sehr hohe Hitzebeständigkeit, daher ideal für den Einsatz im Backofen oder auf dem Grill  
ideal für die Zubereitung knuspriger Steinofenpizza



## Flammkuchenbrett

tarte flambée paddle  
pelle à tarte flambée  
paletta per Flammkuchen  
pala para tarte flambée  
tarte flambée schep

L/B cm	inch	Art.-Nr.	EAN
52,0 x 32,0	20½ x 12½	10 8660 10 00	4 007371 059411

Buchenholz, natur



## Pizza-Schieber

pizza paddle  
pelle à pizza  
paletta per pizza  
pala para pizza  
pizzaschep

L/B cm	inch	Art.-Nr.	EAN
45,0 x 29,5	18 x 11½	10 8650 10 00	4 007371 049351

Holz, natur



## Pizzaschneider

pizza cutter  
roulette à pizza  
rotella tagliapizza  
cortador pizzas  
pizza snijder

L/B cm	inch	Art.-Nr.	EAN
10,0 x 11,0	4 x 4½	08 0497 00 00	4 007371 055383

12 Stück im attraktiven Verkaufs-Display, farblich sortiert





# Pâtissier

Das Herstellen süßer Naschereien wie Popcakes oder Pralinen wird mit den praktischen Komplett-Sets zum Kinderspiel. Die beiliegenden Rezepthefte geben auch Anregungen für herzhaftere Häppchen und Snacks.

# Backen

Ob Plätzchenausstecher, Keksstempel für Ostern oder Weihnachten, praktische Tortenringe oder Kuchengitter sowie Tortenformen mit Heheboden – KÜCHENPROFI bietet eine interessante Produktpalette, die das Herz der Kuchenbäcker höher schlagen lässt.



*Pâtissier*





**Anleitung:**

Aus einem kleinen Behälter eine kleine Menge Soße in den Dekorierlöffel nehmen. Die Spitze des Löffels aufrecht auf den Teller setzen, dann mit dieser über das Porzellan gleiten. Ideal für Unterschriften oder Dekorationen z.B. mit: Salziger Soße, Tomatensoße, Schokoladensoße, Karamellsoße

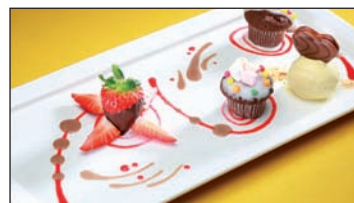

**Dekorierlöffel,  
2er Set**

garnishing spoon  
cuillère à décorer  
cuchiao per decorare  
cuchara decoradora  
decoreerlepel



Länge cm	inch	Art.-Nr.	EAN	GP
19,0 + 23,0	7½ + 9	08 0501 25 02	4 007371 057240	

**Dekorierlöffel,  
2er Set**

garnishing spoon  
cuillère à décorer  
cuchiao per decorare  
cuchara decoradora  
decoreerlepel



Länge cm	inch	Art.-Nr.	EAN	GP
19,0 + 23,0	7½ + 9	08 0501 28 02	4 007371 057257	

## Stilvolle Zubereitung Backen / Dekorieren



### Dekorier-Set, 7-teilig

decorating set  
ensemble à decorer  
set per decorare  
set para decorar  
decoratieset

Art.-Nr. EAN

08 0502 28 00



**Das Set enthält:** 4 Dekorier-Ringe aus Edelstahl (Ø 9 cm), 2 Dekorier-Löffel aus Edelstahl mit Silikongriff (klein: 19 cm, groß: 23 cm), 1 Auslöser, Rezeptbuch



### Rührlöffel-Set mit Thermometer, 3-teilig

pastry spoon and spatula  
with Thermometer  
râcloir et cuillère à pâte  
avec thermometre  
lecca et cucchiaio piatti  
con termometro  
espátula e cuchara masa  
con termómetro  
deegschrapper en -lepel  
met thermometer

Art.-Nr. EAN

08 0503 55 00



**Das Set enthält:** 1 Rührlöffel (26,5 cm), 1 Schaber (26 cm), 1 digitales Thermometer (30 cm, -20°C – 240°C), 1 Batterie (LR44), Bedienungsanleitung



Exakte Temperaturkontrolle direkt beim Rühren.



### Fondant-Trichter-Set, mit 3 Tüllen

confectionery funnel set  
entonnoir doseur  
imbuto colare  
embudo dosificador  
suikergiet trechter

Ø cm Ø inch

14,0

5½

Art.-Nr. EAN

08 0504 66 00



**Das Set enthält:** Trichter mit abnehmbarem Hebel (Inhalt 500 ml), 3 Tüllen und 1 Verschluss, Standfuß, Rezeptbuch



### Spritzbeutel-Set, mit 9 Tüllen

icing set  
poche à douille  
tasca da pasticceria  
manga pastelera  
spuitzak

cm inch

33,0

13

Art.-Nr. EAN

08 0505 55 00



**Das Set enthält:** 1 Spritzbeutel aus Silikon, 1 Ständer, 9 Tüllen mit Auslaufstopp, 1 Adapter für leichtes Wechseln der Tüllen, 2 Verschlussringe, 1 Schieber, Rezeptbuch

Fassungsvermögen Spritzbeutel: max. 1 ltr



### Mini-Tartelettes-Set, 3-teilig

mini tartlets set  
ensemble de tartelettes mini  
set per mini-tartelettes  
set para mini-tartelettes  
Mini-tarteletteset

L/B cm inch

30,0 x 18,0

11½ x 7

Art.-Nr. EAN

08 0506 55 00



**Das Set enthält:** 3 Silikonbackmatten (rund, eckig, oval), 3 Teigausstecher, 6 Einweg-Spritzbeutel inklusive 5 Tüllen und Adapter für leichtes Wechseln der Tüllen, Rezeptbuch



GP = Produkt in farbigem Geschenkkarton



KE = auf Karte mit Euroloch

## Stilvolle Zubereitung Backen / Dekorieren



### Tartelettes-Set, 3-teilig

tartlets set  
ensemble de tartelettes  
set per tartelettes  
set para tartelettes  
tarteletteset

L/B cm	inch	Art.-Nr.	EAN	
36,0 x 23,0	14 x 9	08 0507 55 00	4 007371 058179	

**Das Set enthält:** 2 Silikonbackmatten (8er: Ø 8 cm, 6er: Ø 11 cm), 1 Teigausstecher, Rezeptbuch

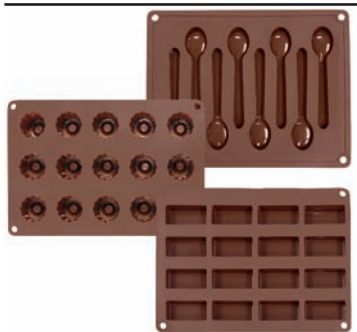

### Gourmet-Set, 3-teilig

gourmet set  
ensemble de gourmet  
set per gourmet  
set para gourmet  
gourmet set

Art.-Nr.	EAN	
08 0508 55 00	4 007371 058186	

**Das Set enthält:** 1 Silikonbackmatte für Schokoladen- oder Gebäcklöffel (23,0 x 18,0 x 0,8 cm), 1 Silikonbackmatte für Cannelés (29,7 x 17,5 x 3,5 cm), 1 Silikonbackmatte für Mini-Financiers (29,7 x 17,5 x 1 cm), Rezeptbuch



### Pralinen-Set, 7-teilig

chocolate set  
ensemble à chocolats  
set per praline  
set para praliné  
pralineset

L/B cm	inch	Art.-Nr.	EAN	
21,5 x 10,5	8½ x 4	08 0509 55 00	4 007371 058193	

**Das Set enthält:** 4 Silikonbackmatten (Herz, rund, Halbmond, quadratisch), 1 Abtropfgitter, Winkelpalette, 1 Pinsel, Rezeptbuch



### Popcake-Set »Mini«

cake pop set »Mini«  
ensemble de Popcake mini  
set per mini-Popcake  
set para mini-Popcake  
Mini-Popcakeset

L/B/Ø cm	inch	Art.-Nr.	EAN	
23,0 x 11,5 x 3	9 x 2½ x 1	08 0510 55 00	4 007371 058209	

**Das Set enthält:** 1 Silikonbackmatte, 1 Deckel, 30 Papier-Stäbchen, Rezeptbuch

Popcake Stiele	Art.-Nr.	EAN	
60 Stück (Länge 12 cm)	08 0510 00 12	4 007371 059909	



### Popcake-Set »Classic«

cake pop set „Classic“  
ensemble de Popcake Classic  
set per Popcake Classic  
set para Popcake Classic  
Popcakeset Classic

L/B/Ø cm	inch	Art.-Nr.	EAN	
30,0 x 11,5 x 4	12 x 2½ x 1½	08 0511 55 00	4 007371 058216	

**Das Set enthält:** 1 Silikonbackmatte, 1 Deckel, 48 Papier-Stäbchen, Rezeptbuch

Popcake Stiele	Art.-Nr.	EAN	
48 Stück (Länge 10 cm)	08 0511 00 10	4 007371 059916	

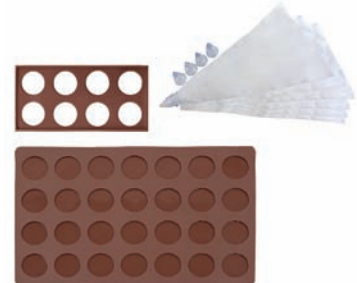

### Macaron-Set





























macaron set  
ensemble pour macarons  
set per macarons  
set para macarrón  
macaron set

L/B/Ø cm	inch	Art.-Nr.	EAN	
36,5 x 23,5 x 4	14½ x 9 x 1½	08 0512 55 00	4 007371 058223	

**Das Set enthält:** 1 Silikonbackmatte, 1 Einfüllhilfe, Einweg-Spritzbeutel inklusive 5 Tüllen und Adapter für leichtes Wechseln der Tüllen, Rezeptbuch



## Backen / Dekorieren

	<p><b>Ausstecher »Universal«,</b> 4 Motive im Set</p> <p>cookie cutter emporte-pièce coppapasta molde para galleas uitsteekvormpjes</p>	<table border="1"> <tr> <td>Art.-Nr.</td> <td>EAN</td> <td></td> </tr> <tr> <td><b>08 1500 28 04</b></td> <td>4 007371 057080</td> <td></td> </tr> </table>	Art.-Nr.	EAN		<b>08 1500 28 04</b>	4 007371 057080							
Art.-Nr.	EAN													
<b>08 1500 28 04</b>	4 007371 057080													
<p><b>Das Set enthält:</b> 4 Ausstecher mit Auslöser, Motive: Herz, Bär, Erdbeere, Blatt</p>														
	<p><b>Ausstecher »X-MAS«,</b> 4 Motive im Set</p> <p>cookie cutter emporte-pièce coppapasta molde para galleas uitsteekvormpjes</p>	<table border="1"> <tr> <td>Art.-Nr.</td> <td>EAN</td> <td></td> </tr> <tr> <td><b>08 1501 28 04</b></td> <td>4 007371 057097</td> <td></td> </tr> </table>	Art.-Nr.	EAN		<b>08 1501 28 04</b>	4 007371 057097							
Art.-Nr.	EAN													
<b>08 1501 28 04</b>	4 007371 057097													
<p><b>Das Set enthält:</b> 4 Ausstecher mit Auslöser, Motive: Weihnachtskugel, Lebkuchenmann, Schneemann, Weihnachtsbaum</p>														
	<p><b>Ausstecher »Ostern«,</b> 4 Motive im Set</p> <p>cookie cutter emporte-pièce coppapasta molde para galleas uitsteekvormpjes</p>	<table border="1"> <tr> <td>Art.-Nr.</td> <td>EAN</td> <td></td> </tr> <tr> <td><b>08 1502 28 04</b></td> <td>4 007371 057103</td> <td></td> </tr> </table>	Art.-Nr.	EAN		<b>08 1502 28 04</b>	4 007371 057103							
Art.-Nr.	EAN													
<b>08 1502 28 04</b>	4 007371 057103													
<p><b>Das Set enthält:</b> 4 Ausstecher mit Auslöser, Motive: Küken, Schmetterling, Hase, Ei</p>														
	<p><b>Linzer Ausstecher-Set,</b> 8 verschiedenen Formen inklusive Auswerfer</p> <p>linzer cookie cutter set emporte-pièce pour biscuits de Linz stampo per biscotti di Linz cortadores para galletas linzer vormpjes voor Linzer koekjes</p>	<table border="1"> <tr> <td>Art.-Nr.</td> <td>EAN</td> <td></td> </tr> <tr> <td><b>08 1509 28 04</b></td> <td>4 007371 058100</td> <td></td> </tr> </table>	Art.-Nr.	EAN		<b>08 1509 28 04</b>	4 007371 058100							
Art.-Nr.	EAN													
<b>08 1509 28 04</b>	4 007371 058100													
<p><b>Das Set enthält:</b> 8 verschiedene Formen inklusive Auswerfer</p>														
	<p><b>Keks-Stempel »X-MAS«,</b> 4-teilig</p> <p>cookie stamp timbre pour biscuits stampo per biscotti timbre para galletas koekstempel</p>	<table border="1"> <tr> <td>Ø cm</td> <td>Höhe cm</td> <td>Ø inch</td> <td>Art.-Nr.</td> <td>EAN</td> <td></td> </tr> <tr> <td>8,0</td> <td>10,0</td> <td>3</td> <td><b>08 1510 55 03</b></td> <td>4 007371 060547</td> <td></td> </tr> </table>	Ø cm	Höhe cm	Ø inch	Art.-Nr.	EAN		8,0	10,0	3	<b>08 1510 55 03</b>	4 007371 060547	
Ø cm	Höhe cm	Ø inch	Art.-Nr.	EAN										
8,0	10,0	3	<b>08 1510 55 03</b>	4 007371 060547										
<p><b>Das Set enthält:</b> 1 Stempel, 3 Motive: Schneeflocke, Weihnachtsbaum mit Schriftzug »Christmas«, Lebkuchenmann</p>														
	<p><b>Keks-Stempel »Universal«,</b> 4-teilig</p> <p>cookie stamp timbre pour biscuits stampo per biscotti timbre para galletas koekstempel</p>	<table border="1"> <tr> <td>Ø cm</td> <td>Höhe cm</td> <td>Ø inch</td> <td>Art.-Nr.</td> <td>EAN</td> <td></td> </tr> <tr> <td>8,0</td> <td>10,0</td> <td>3</td> <td><b>08 1511 55 03</b></td> <td>4 007371 060554</td> <td></td> </tr> </table>	Ø cm	Höhe cm	Ø inch	Art.-Nr.	EAN		8,0	10,0	3	<b>08 1511 55 03</b>	4 007371 060554	
Ø cm	Höhe cm	Ø inch	Art.-Nr.	EAN										
8,0	10,0	3	<b>08 1511 55 03</b>	4 007371 060554										
<p><b>Das Set enthält:</b> 1 Stempel, 3 Motive: Schmetterling, Marienkäfer, Eule</p>														
	<p><b>Keks-Stempel »Ostern«,</b> 4-teilig</p> <p>cookie stamp timbre pour biscuits stampo per biscotti timbre para galletas koekstempel</p>	<table border="1"> <tr> <td>Ø cm</td> <td>Höhe cm</td> <td>Ø inch</td> <td>Art.-Nr.</td> <td>EAN</td> <td></td> </tr> <tr> <td>8,0</td> <td>10,0</td> <td>3</td> <td><b>08 1512 55 03</b></td> <td>4 007371 060592</td> <td></td> </tr> </table>	Ø cm	Höhe cm	Ø inch	Art.-Nr.	EAN		8,0	10,0	3	<b>08 1512 55 03</b>	4 007371 060592	
Ø cm	Höhe cm	Ø inch	Art.-Nr.	EAN										
8,0	10,0	3	<b>08 1512 55 03</b>	4 007371 060592										
<p><b>Das Set enthält:</b> 1 Stempel, 3 Motive: Osterei, Osterhase, Blume mit Schriftzug »Happy Easter«</p>														

## Backen / Dekorieren

### Garnierspritze »Profi«



decorating and garnishing injection  
seringue à décorer et garnir  
siringa per decorare  
jeringa para decorar  
decoratie-en garneerspuit

Länge cm	inch	Art.-Nr.	EAN
24,0	9½	08 0560 28 00	4 007371 044387

aus Edelstahl rostfrei  
inklusive 7 verschiedenen Tüllen

### Dekorierflasche mit 2 Tüllen



decorating squeeze bottle  
outeile à décorer  
bottiglia per decorare  
botella para decorar y racionar  
dresseerfles

Ø cm	H cm	Inhalt	Ø inch	Art.-Nr.	EAN
5,5	13,0	100 ml	2	08 0569 00 00	4 007371 060493

20 Stück im attraktiven Verkaufs-Display,  
farblich sortiert



### Dekorier-/Garnierset



decorating set  
ensemble à décorer et garnir  
set per decorare  
jeringa para decorar  
decoratie- en garneerset

Art.-Nr.	EAN
08 0570 00 06	4 007371 055031

Set besteht aus:  
3 Ziehharmonikaflaschen, 100 ml; 1 Zweikammernflasche, je 100 ml,  
1 Dekorierflasche, 200 ml, 1 Spatel, 5 Edelstahl-Tüllen

### Muffin-Form, »Herz«



cup cake mould  
moule à muffin  
forma per muffin  
forma por muffin  
muffinvorm

Ø cm	Höhe cm	Ø inch	Art.-Nr.	EAN
6,5	2,5	2½	08 0571 55 06	4 007371 055871

aus Silikon  
6er-Set (grün, dunkelblau, hellblau, rot, orange, gelb)  
geeignet für Spülmaschine, Backofen bis 260°C, Mikrowelle

### Spritzbeutel-/Dekorierset



icing bag  
poche à douille  
tasca da pasticceria  
manga pastelera  
spuitzak

Länge cm	inch	Art.-Nr.	EAN
30,0	12	08 0580 00 00	4 007371 055901

Spritzbeutel aus Baumwolle, beschichtet/hochwertiger Kunststoff  
inklusive 4 verschiedenen Tüllen



## Backen / Dekorieren



### Tortenring verstellbar, rund

cake ring  
cercle à pâtisserie  
anello per torta  
aro de tarta  
taartring

Ø cm	Höhe cm	Ø inch	Art.-Nr.	EAN
16,0	8,5	6½	08 0583 28 00	4 007371 057851

mit Griffen zum stufenlosen Einstellen von Ø 16 bis 30 cm



### Tortenring verstellbar, mit Unterteiler, rechteckig

cake ring, rectangular  
cadre à pâtisserie rectangulaire  
anello per torta rettangolare  
aro de tarta rectangular  
taartring rechthoekig

L/B/H cm	inch	Art.-Nr.	EAN
18,5 x 27,5 x 5,0	7 x 11 x 2	08 0584 28 00	4 007371 057868

zum stufenlosen Einstellen von 18,5 x 27,5 bis 34,0 x 52,5 cm  
mit Unterteiler für gleichzeitiges Backen  
von 2 unterschiedlichen Kuchen



### Konditormesser-Set, 3-teilig

icing spatula set  
ensemble de couteaux de pâtissier  
set di coltelli da pasticciere  
set del cuchillos de pasteleros  
paletmessen set

Art.-Nr.	EAN
08 0585 28 03	4 007371 057127

Das Set enthält: 1 Tortenmesser mit Wellenschliff und glatter Seite (39 cm), 1 Palette (29 cm), 1 Winkelpalette (25 cm)



### Kuchengitter

cooling rack  
volette à gateaux  
raffreddatore rotondo  
enfriador de tartas  
tartenkoeler

Ø cm	Ø inch	Art.-Nr.	EAN
36,0	14	08 0587 28 36	4 007371 060684



### Pudding-Form, 6er Set

pudding mould  
moule à pudding  
stampo per budino  
moldes de flan y pudin  
puddingvorm

Ø cm	Höhe cm	Ø inch	Art.-Nr.	EAN
7,5	6,0	3	08 0590 14 06	4 007371 055918

hochwertiger Kunststoff  
Inhalt: 150 ml, temperaturbeständig bis: 90°C,  
inklusive Belüftungsdeckel zum leichteren Stürzen des Puddings



### Pudding-Form

pudding mould  
moule à pudding  
stampo per budino  
moldes de flan y pudin  
puddingvorm

Ø cm	Höhe cm	Ø inch	Art.-Nr.	EAN
15,0	11,0	6	08 0600 14 00	4 007371 055925

hochwertiger Kunststoff  
Inhalt: 1 ltr., temperaturbeständig bis: 90°C,  
inklusive Belüftungsdeckel zum leichteren Stürzen des Puddings



## Backen / Dekorieren

### Tarte- und Quicheform



quiche pan  
moule à tarte  
stampo torta  
molde de tarta  
taartvorm

Ø cm	Höhe cm	Ø inch	Art.-Nr.	EAN	GP
28,0	3,0	11	08 1000 10 28	4 007371 056823	
28,0	3,0	11	08 1000 14 28	4 007371 056830	

mit Hebeboden  
antihafbeschichtet



### Tarteletteform, 4 Stück im Set



round flan dish  
moule à tartelette  
stampo torta  
molde de tarta  
taartvorm

Ø cm	Höhe cm	Ø inch	Art.-Nr.	EAN	GP
11,5	3,0	4½	08 1001 10 04	4 007371 056847	
11,5	3,0	4½	08 1001 14 04	4 007371 056854	

mit Hebeboden  
antihafbeschichtet



### Springform »Herz«



springform pan  
moule à charnières  
teglia con fondo staccabile  
molde de tarta  
springvorm

L/B/H cm	inch	Art.-Nr.	EAN	GP
11,5 x 11,0 x 4,5	4½ x 4½ x 2	08 1002 10 12	4 007371 056861	
11,5 x 11,0 x 4,5	4½ x 4½ x 2	08 1002 14 12	4 007371 056878	

mit Hebeboden  
antihafbeschichtet



## Backen / Dekorieren

### Blindbackkugeln



baking beans  
billes de cuisson  
sfere per cottura  
judias para tartas  
blindbakbonen

Art.-Nr. EAN

08 1010 83 00



Keramik,  
Inhalt: 850g  
zum Blindbacken von Pies, Tartes und Quiches,  
ausreichend für Backformen bis 30 cm

### Fleischwolf mit Spritzgebäckvorsatz



meat grinder  
hachoir à viande  
tritacarne  
triturador de carne  
gehaktmolen

Ø cm Ø inch Art.-Nr. EAN



Größe 5

5,0

2

08 0255 30 05



Größe 8

8,0

3

08 0255 30 08



### Messbecher, mit Griff



measuring cup  
gobelet mesureur  
misurino cucina  
jarra medidora  
maatbeker

Ø cm Höhe cm Inhalt ltr. Ø inch Art.-Nr. EAN

10,5

14,5

1,0

2½

09 1180 28 10



### Marmor-Teigrolle mit Holzgriffen



rolling pin  
rouleau pâtisserie marbre  
mattarello marmo  
rodillo pasta  
deegrol marmer

Ø cm Länge cm inch Art.-Nr. EAN

6,0

47,0

10½

10 0248 10 47



Marmor und Holz, inklusive Ablage

### Einhand-Mehlsieb



flour sieve  
saupoudreur tamis farine  
passafarina  
jarra tamiz  
schudzeef

Ø cm Höhe cm Ø inch Art.-Nr. EAN

9,5

9,0

3½

10 0700 28 00



### Silikon-Teigschaber/ Eierwender

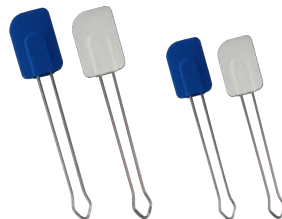

pastry scraper  
râcloir à pâte  
lecca piatti  
espátula masa  
deegschrapper

Design: Ralph Krämer

Länge cm inch Art.-Nr. EAN

blau

29,5

11½

10 0805 12 00



weiß

29,5

11½

10 0805 22 00



blau

25,5

10

10 0807 12 00



weiß

25,5

10

10 0807 22 00



## Backen / Dekorieren



### Teigschaber »Fancy«

pastry scraper  
râcloir à pâte  
lecca piatti  
espátula masa  
deegschrapper

	Länge cm	inch	Art.-Nr.	EAN
grün	30,5	12	10 0816 11 00	4 007371 058919
blau	30,5	12	10 0816 12 00	4 007371 058926
rot	30,5	12	10 0816 14 00	4 007371 058933
orange	30,5	12	10 0816 15 00	4 007371 058940
gelb	30,5	12	10 0816 16 00	4 007371 058957
pink	30,5	12	10 0816 21 00	4 007371 058964

Temperaturbeständige Silikon-Laffe: -60°C bis +300°C



### Kinderschürze, mit 2 Handschuhen

children's apron with 2 gloves  
ensemble de tablier 2 et gants  
set con parannanza e 2 guanti  
juego de mandil 2 y guantes  
set met schort en 2 keukenhandschoenen

L/B cm	inch	Art.-Nr.	EAN	GP
60,0 x 46,0 cm	23½ x 18	10 6020 12 00	4 007371 058087	

100% Baumwolle



### Kuchenthermometer

cake thermometer  
thermomètre à gâteau  
termometro per torta  
termómetro para torta  
koekthermomete

Länge cm	Ø	inch	Art.-Nr.	EAN	GP
11,5	4,5	4½	10 6509 28 00	4 007371 058117	



### Kuchenretter/Pizzaheber

cake lifter / pizza server  
pelle à pizza/tarte  
pala pizza/tarta  
paleta para pizza y pasteles  
taart-/pizzaschep

L/B cm	inch	Art.-Nr.	EAN	GP
36,0 x 25,0 cm	14 x 10	10 8900 28 00	4 007371 050463	



# Praktische Küchenhelfer

Brotkästen, Küchenwaagen im Nostalgie-Look sowie unersetzliche Helfer für den täglichen Einsatz in der Küche prägen das gesamte KÜCHENPROFI Sortiment und erleichtern die Arbeit in der Küche.





# Brotkästen

rostfrei/pulverbeschichtet / stainless/powder-coated

Praktische Küchenhelfer

## Brotkasten »Corona«

bread box  
boîte a pain  
porta pane  
centro pan  
broodtrommel

L/B/H cm	inch	Art.-Nr.	EAN	
42,5 x 22,5 x 17	16 7/8 x 9 x 6 7/8	09 0316 10 00	4 007371 059176	



Belüftungslöcher auf der Rückseite sorgen für ein optimales Klima, rutschfeste Füßchen



  
Kurz Kurz Design

## Brotkasten »Corona«

bread box  
boîte a pain  
porta pane  
centro pan  
broodtrommel

L/B/H cm	inch	Art.-Nr.	EAN	
42,5 x 22,5 x 17	16 7/8 x 9 x 6 7/8	09 0316 11 00	4 007371 059183	



Belüftungslöcher auf der Rückseite sorgen für ein optimales Klima, rutschfeste Füßchen



  
Kurz Kurz Design

## Brotkasten »Corona«

bread box  
boîte a pain  
porta pane  
centro pan  
broodtrommel

L/B/H cm	inch	Art.-Nr.	EAN	
42,5 x 22,5 x 17	16 7/8 x 9 x 6 7/8	09 0316 14 00	4 007371 059190	



Belüftungslöcher auf der Rückseite sorgen für ein optimales Klima, rutschfeste Füßchen



  
Kurz Kurz Design

## Brotkasten »Corona«

bread box  
boîte a pain  
porta pane  
centro pan  
broodtrommel

L/B/H cm	inch	Art.-Nr.	EAN	
42,5 x 22,5 x 17	16 7/8 x 9 x 6 7/8	09 0316 22 00	4 007371 059206	

Belüftungslöcher auf der Rückseite sorgen für ein optimales Klima, rutschfeste Füßchen



  
Kurz Kurz Design

 GP = Produkt in farbigem Geschenkkarton

 KE = auf Karte mit Euroloch

# Küchenwaagen

Edelstahl rostfrei / stainless steel



## Küchenwaage »Nostalgie«

kitchen scales  
balance de cuisine  
bilancia per la cucina  
balanza cocina  
keuken-weegschaal

L/B/H cm	inch	Art.-Nr.	EAN	GP
21,0 x 20,0 x 25,0	8¼ x 7¾ x 9¾	09 0330 28 00	4 007371 033824	

Wiegebereich: bis 2 kg in 10g-Schritten  
Fassungsvermögen der abnehmbaren Schale: 1 ltr.



## Küchenwaage »Nostalgie«

kitchen scales  
balance de cuisine  
bilancia per la cucina  
balanza cocina  
keuken-weegschaal

L/B/H cm	inch	Art.-Nr.	EAN	GP
21,0 x 20,0 x 25,0	8¼ x 7¾ x 9¾	09 0330 10 00	4 007371 060014	

Wiegebereich: bis 2 kg in 10g-Schritten  
Fassungsvermögen der abnehmbaren Schale: 1 ltr.



## Küchenwaage »Nostalgie«

kitchen scales  
balance de cuisine  
bilancia per la cucina  
balanza cocina  
keuken-weegschaal

L/B/H cm	inch	Art.-Nr.	EAN	GP
21,0 x 20,0 x 25,0	8¼ x 7¾ x 9¾	09 0330 14 00	4 007371 060028	

Wiegebereich: bis 2 kg in 10g-Schritten  
Fassungsvermögen der abnehmbaren Schale: 1 ltr.



## Küchenwaage »Nostalgie«

kitchen scales  
balance de cuisine  
bilancia per la cucina  
balanza cocina  
keuken-weegschaal

L/B/H cm	inch	Art.-Nr.	EAN	GP
21,0 x 20,0 x 25,0	8¼ x 7¾ x 9¾	09 0330 22 00	4 007371 060038	

Wiegebereich: bis 2 kg in 10g-Schritten  
Fassungsvermögen der abnehmbaren Schale: 1 ltr.



# Praktische Küchenhelfer

Edelstahl rostfrei / stainless steel

Praktische Küchenhelfer



## Fleischklopper »Classic«

meat pounder  
 marteau à viande  
 batticarne  
 mazo de cocina  
 vleesklopper

Ø cm	Höhe cm	Ø inch	Art.-Nr.	EAN	
8,0	12,0	3	08 0101 28 08	4 007371 008563	

Gewicht: ca. 800 g



## Fleischklopper/ Küchenbeil

meat pounder / cleaver  
 marteau à viande / hachette  
 batticarne / accetta per carne  
 mazo de cocina / hachuela  
 vleesklopper

Länge cm	inch	Art.-Nr.	EAN	
27,5	11	08 0103 28 00	4 007371 039789	

Gewicht: ca. 330 g



## Fleischklopper

meat pounder  
 marteau à viande  
 batticarne  
 mazo de cocina  
 vleesklopper

Ø cm	Länge cm	Ø inch	Art.-Nr.	EAN	
10,0	25,5	4	08 0104 28 00	4 007371 040204	

Gewicht: ca. 860 g



## Fleischklopper »Chef«

meat pounder  
 marteau à viande  
 batticarne  
 mazo de cocina  
 vleesklopper

Länge cm	inch	Art.-Nr.	EAN	
25,0	10	08 0105 28 00	4 007371 047876	

Gewicht: ca. 400 g



## Panier-Set, 3-teilig

breeding set, 3 pcs.  
 ensemble pour paner, 3 pcs.  
 set per impanare, 3 pz.  
 set para empanar, 3 pzs.  
 paneer-set, 3-dlg.

L/B/H cm	inch	Art.-Nr.	EAN	
22,0 x 15,0 x 3,0	8½ x 6 x 1	08 0110 28 03	4 007371 038690	

zum Panieren, Marinieren, Portionieren

# Praktische Küchenhelfer

Edelstahl rostfrei / stainless steel

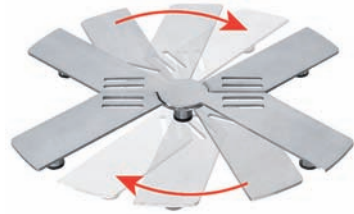

## Untersetzer, verstellbar

adjustable trivet  
dessous de plat ajustable  
sottopentola orientabile  
salvamanteles ajustable  
onderzetter verstelbaar

L/B/H cm	inch	Art.-Nr.	EAN
26,0 x 17,5	10 x 3	08 0126 28 00	4 007371 057844

Verstellbar von 26 cm x 8 cm bis 22 cm x 17,6 cm



## Trüffelhobel

truffle plane  
râpe à truffe  
tagliatartufi  
cortadora de trufa  
truffelrasp

L/B cm	inch	Art.-Nr.	EAN
17,5 x 8,5	7 x 3½	08 0406 28 00	4 007371 010580

auch für Parmesan u. a.  
Schnittstärke bis 3 mm



## Spritzschutzsieb »Deluxe«

anti splash sieve  
tamis anti-éclaboussure  
paraspruzzi  
pasador anti saipicados  
spatzeef

Ø cm	Ø inch	Art.-Nr.	EAN
29,0	11½	08 0805 28 29	4 007371 043618

passend bis Ø 28 cm

33,0	13	08 0810 28 33	4 007371 043625
------	----	---------------	-----------------

passend bis Ø 32 cm



## Spritzschutzsieb

anti splash sieve  
tamis anti-éclaboussure  
paraspruzzi  
pasador anti saipicados  
spatzeef

Ø cm	Ø inch	Art.-Nr.	EAN
29,0	11½	08 0810 28 29	4 007371 035712

passend bis Ø 28 cm

33,0	13	08 0810 28 33	4 007371 041041
------	----	---------------	-----------------

passend bis Ø 32 cm



## Abgieß-Sieb

pour off sieve  
tamis égouttoir  
colino  
pasador vertidora  
afgietzeef

Breite cm	inch	Art.-Nr.	EAN
33,5	13	08 0821 28 00	4 007371 034364

passend bis Ø 24 cm



## Siebeinsatz »sinkstation™«, für die Spüle; Kunststoff

flat colander  
égouttoir plat  
colapasta  
escurreverduras  
plat vergiet

L/B cm	inch	Art.-Nr.	EAN
34,0 x 27,0	13½ x 11	08 0835 11 00	4 007371 056649

mit praktischen Füßen und seitlichem Ablauf,  
ideal beim Putzen von Gemüse, Waschen von Salat oder Beeren oder  
Abgießen von Resten  
nicht geeignet für runde Spülbecken



# Dessert- und Vorspeisenringe

Edelstahl rostfrei / stainless steel

## Dessert- und Vorspeisenringe, 6-teilig

decorating and dessert rings  
emporte-pièce  
aro decorador  
formina anello  
kook- en dessertring



Art.-Nr.	EAN	
09 0498 28 06	4 007371 054782	

### Set besteht aus:

2 Dessert- und Vorspeisenringen Ø 7,5 cm,  
2 Dessert- und Vorspeisenringen Ø 5 cm,  
1 Auslöser Ø 7,25 cm, 1 Auslöser Ø 4,85 cm

## Dessert- und Vorspeisenringe »Mixed«

decorating and dessert rings  
emporte-pièce  
aro decorador  
formina anello  
kook- en dessertring



Höhe cm	inch	Art.-Nr.	EAN	
5,0	2	09 0500 28 04	4 007371 043885	

4 Stück im Set:

2 Stück mit Ø 8 cm und 2 Stück mit Ø 6 cm

## Dessert- und Vorspeisenringe

decorating and dessert rings  
emporte-pièce  
aro decorador  
formina anello  
kook- en dessertring



Höhe cm	Ø	inch	Art.-Nr.	EAN
5,0	8 cm	2	09 0505 28 00	4 007371 051873

18 Stück im attraktiven Verkaufs-Display

## Dessert- und Vorspeisenringe »Grande«

decorating and dessert rings  
emporte-pièce  
aro decorador  
formina anello  
kook- en dessertring



Höhe cm	Ø	inch	Art.-Nr.	EAN	
5,0	8 cm	2	09 0505 28 04	4 007371 045445	

4 Stück im Set

## Dessert- und Vorspeisenring, verstellbar

decorating and dessert rings  
emporte-pièce  
aro decorador  
formina anello  
kook- en dessertring



Höhe cm	inch	Art.-Nr.	EAN	
5,5	2	09 0509 28 00	4 007371 052672	

Ø 7,0 - 9,0

18 Stück im attraktiven Verkaufs-Display



# Terrinen

Edelstahl rostfrei / stainless steel

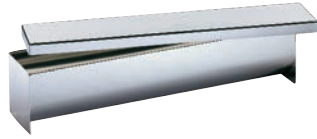

## Terrinenform mit Deckel, rund

tureen mould  
terrine  
terrina  
terrina  
patévorm

L/B/H cm	Inhalt ltr.	inch	Art.-Nr.	EAN
30,5 x 6,0 x 6,0	0,7	12 x 2½ x 2½	09 2101 28 00	4 007371 033497

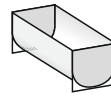

## Terrinenform mit Deckel, rund

tureen mould  
terrine  
terrina  
terrina  
patévorm

L/B/H cm	Inhalt ltr.	inch	Art.-Nr.	EAN
23,5 x 8,0 x 7,5	0,9	9 x 3 x 3	09 2106 28 00	4 007371 045858

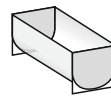

## Terrinenform mit Deckel, Dreieck

tureen mould  
terrine  
terrina  
terrina  
patévorm

L/B/H cm	Inhalt ltr.	inch	Art.-Nr.	EAN
30,0 x 5,5 x 5,5	0,45	12 x 2 x 2	09 2107 28 00	4 007371 045865

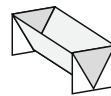

## Terrinenform mit Füllungseinsatz

tureen mould  
terrine  
terrina  
terrina  
patévorm

Ø cm	Höhe cm	Inhalt ltr.	Ø inch	Art.-Nr.	EAN
7,5	12,0	0,5	3	09 2120 28 00	4 007371 057592



difo  
Design International



## Dekorierschneider, 4-teilig

decoration cutter  
evideur pour decorer  
taglia per decorare  
cortador para decorar  
decoratie snijder

Länge cm	inch	Art.-Nr.	EAN
11,0	4½	09 2130 28 04	4 007371 057677

**Ergänzung zur Terrinenform mit Füllungseinsatz**  
Das Set enthält: 1 Griff, 4 Dekorierschneider - Motive: Stern, Kreuz, Blume, Herz, 1 Bedienungsanleitung



GP = Produkt in farbigem Geschenkkarton

KE = auf Karte mit Euroloch

# Praktische Küchenhelfer

Edelstahl rostfrei / stainless steel

Praktische Küchenhelfer



## Kühlschrank-Butterdose

butter dish  
beurrier  
porta burro  
mantequera  
botervloot

L/B/H cm	inch	Art.-Nr.	EAN
16,0 x 10,0 x 5,0	6 1/4 x 4 x 2	09 1202 28 00	4 007371 035040

für 1/2 Pfund Butter (250g)



## Kühlschrank-Butterdose

butter dish  
beurrier  
porta burro  
mantequera  
botervloot

L/B/H cm	inch	Art.-Nr.	EAN
10,0 x 13,0 x 4,0	4 x 5 x 1 1/2	09 1203 28 00	4 007371 035798

für 1/4 Pfund Butter (125g)



## Pellkartoffel-Set

jacket potato fork  
and knife set  
set fourchette et couteau  
à pomme de terre  
set coltello e forchetta per patate  
tenedor y cuchillo set  
para patatas cocidas  
aardappel pel-set

Länge cm	inch	Art.-Nr.	EAN
15,0	6	09 1350 28 00	4 007371 042772

4 Stück im Set: 2 x Gabel und 2 x Messer



## Tomatenstrunkentferner

tomato corer  
évideur à tomate  
attrezzo togliorsolo pomodoro  
vaciador del corazón del tomate  
tomaatkroon-verwijderaar

Länge cm	inch	Art.-Nr.	EAN
13,0	5	09 1400 28 00	4 007371 046121

24 Stück im attraktiven Verkaufs-Display



## Geflügelschere

poultry scissors  
cisailles à volaille  
trinciapolli  
tijeras aves  
gevogelte-schaar

Länge cm	inch	Art.-Nr.	EAN
25,0	10	09 2300 28 00	4 007371 034906

mit Sicherheitsverschluss



## Geflügelschere »Profi«

poultry scissors  
cisailles à volaille  
trinciapolli  
tijeras aves  
gevogelte-schaar

Länge cm	inch	Art.-Nr.	EAN
24,0	9 1/2	09 2350 28 00	4 007371 047685

mit Sicherheitsverschluss

## Praktische Küchenhelfer

Edelstahl rostfrei / stainless steel

Designed and produced  
by **triangle****Endlos-Spiralschneider**

endless spiral cutter  
coupe-légumes spirale  
taglia a spirale  
cortador en espiral  
oneindige spiraal snijder

L/B cm	inch	Art.-Nr.	EAN	GP
11,0 x 7,5	4½ x 3	09 3500 15 00	4 007371 060318	

**Endlos-Julieneschneider**

endless julienne cutter  
coupe-légumes juliennes  
taglia julienne a spirale  
cortador en juliana  
oneindige julienne snijder

L/B cm	inch	Art.-Nr.	EAN	GP
11,0 x 7,5	4½ x 3	09 3501 14 00	4 007371 060325	

**Aromareibe**

flavour grater  
rape à saveur  
grattugia zenzero/limone  
rallador para especias  
aroma rasp

L/B cm	inch	Art.-Nr.	EAN	GP
19,0 x 4,5	7½ x 1½	09 3502 10 00	4 007371 060332	

**Rettichschneider**

spiral cutter  
trancheur à radis blanc  
tagliarapanelli  
decorador en guirnalda  
rettich snijder

L/B cm	inch	Art.-Nr.	EAN	GP
11,5 x 0,4	4½ x ¼	09 3503 14 00	4 007371 060349	

mit Führungsstab

**Apfelteiler,  
inklusive Unterschale**

apple divider and corer for 16 slices  
trancheur à pomme 16 quartiers  
tagliamele per 16 spicchi  
cortador para manzanas 16 porciones  
appelsnijder voor 16 partjes

L/B cm	inch	Art.-Nr.	EAN	GP
17,5 x 5,5	7 x 2	09 3504 11 00	4 007371 060356	

für 16 Spalten, schneidet den Apfel restlos durch

**Wellenschneider**

crinkle cutter  
coupe légume ondulé  
coltello ondulato  
cortador ondulado  
ribbelsnijder

L/B cm	inch	Art.-Nr.	EAN	GP
9,0 x 9,0	3½ x 3½	09 3505 10 00	4 007371 060363	

für alle festen Gemüsesorten und auch Butter

Design: Ralph Krämer

**Julienne-Set, 3-teilig**

julienne cutter set  
set à julienne  
taglia a julienne  
set de cortadores en juliana  
julienne set

L/B cm	inch	Art.-Nr.	EAN	GP
19,5 x 7,5	7½ x 3	09 3506 10 00	4 007371 060370	

mit 3 auswechselbaren Klingen:  
dünne Julienne, breite Julienne, Scheiben



# Praktische Küchenhelfer

Edelstahl rostfrei / stainless steel



## Fisch-/Spargelzange

fish/asparagus tongs  
pince à poisson  
pinza pesce  
pinzas pescado  
vis-/aspergetang

Länge cm	inch	Art.-Nr.	EAN	
24,0	9½	09 4001 28 00	4 007371 023535	

Design: Ralph Krämer



## Fischgräten-Pinzette

fishbone tweezers  
pincette à arêtes  
pinze per spine di pesce  
pinzas por espina  
gratenpincet

Länge cm	inch	Art.-Nr.	EAN	
12,0	5	09 4007 28 00	4 007371 041140	



## Fischgräten-Pinzette »Deluxe«

fishbone tweezers  
pincette à arêtes  
pinze per spine di pesce  
pinzas por espina  
gratenpincet

Länge cm	inch	Art.-Nr.	EAN	
13,0	5	09 4009 28 00	4 007371 045513	

made in Solingen – Germany



## Fischentschupper

fish scaler  
écailleur  
squamapesce  
descamador para pescado  
visontshubber

Länge cm	inch	Art.-Nr.	EAN	
19,0	7½	09 4010 28 00	4 007371 045704	



## Servierzange

serving tongs  
pince à servir  
pinza per servire  
pinza para frituras  
baktang

Länge cm	inch	Art.-Nr.	EAN	
27,5	11	09 4300 28 00	4 007371 049474	



## Pfannen-/Wendegabel »Deluxe«

turning fork  
fourchette à tourner  
forchetta per rivoltare  
tenedor para remover  
bakfork

Länge cm	inch	Art.-Nr.	EAN	
30,0	12	09 7500 10 00	4 007371 045216	

Funktionsteil aus temperaturbeständigem Nylon (bis 220°C)  
ideal für beschichtete Pfannen

# Passieren, Einkochen und andere Helfer

Regionale und saisonale Produkte stehen wir volles Aroma – leider nur für eine begrenzte Zeit. Zum Verlängern der Genusszeit stehen Ihnen mit den KÜCHENPROFI-Accessoires zum Einkochen die idealen Begleiter zur Seite.



# Passieren und Einmachen

Edelstahl rostfrei / stainless steel

Passieren und Einkochen



## Marmeladen-/Einfülltrichter, 2-teilig

jam funnel  
entonnoir à confiture  
imbuto per marmellata  
embudo para mermelada  
jamtrecther

L/B cm	inch	Art.-Nr.	EAN	
16,5 x 10,5	6½ x 4	09 2009 28 14	4 007371 054959	

mit abnehmbarem Reduziertrichter  
passend für Behälter mit einem  
Öffnungsdurchmesser von 1,5 cm bis 5,5 cm



## Marmeladentrichter mit Siebeinsatz

funnel with filter  
entonnoir avec filtre  
imbuto con filtro  
embudo con filtro  
trechter met filter

Ø cm	Höhe cm	Ø inch	Art.-Nr.	EAN	
13,0	9,0	5	09 2015 28 00	4 007371 038591	

Kurz Kurz Design



## Trichter

funnel  
entonnoir  
imbuto  
embudo  
trechter

Ø cm	Ø inch	Art.-Nr.	EAN	
10,0	4	09 2017 28 10	4 007371 014014	



## Marmeladentrichter

jam funnel  
entonnoir à confiture  
imbuto per marmellata  
embudo para mermelada  
jamtrecther

Ø cm	Ø inch	Art.-Nr.	EAN
14,0	5½	09 2018 28 00	4 007371 015059



## Zuckerthermometer

candy thermometer  
thermomètre à confiture  
termometro per zucchero  
termómetro para azúcar  
suikerthermometer

Länge cm	inch	Art.-Nr.	EAN	
30,0	12	10 6570 28 00	4 007371 048392	

Temperaturbereich 40°C – 200°C / 100°F – 400°F



# Passieren und Einmachen

Edelstahl rostfrei / stainless steel



## Passiergerät, klein

vegetable sieve / food mill  
passoire  
passa verdura  
pasapurés  
passeermolen

Ø cm	Ø inch	Art.-Nr.	EAN
14,0	5½	09 6560 28 14	4 007371 036917

mit fester Scheibe



## Passiergerät »Profi«

vegetable sieve / food mill  
passoire  
passa verdura  
pasapurés  
passeermolen

Ø cm	Ø inch	Art.-Nr.	EAN
20,0	8	09 6600 28 20	4 007371 036665

mit 4 Scheiben



Passierscheibe: 1,3mm

Reibscheibe: 2,5mm

Passierscheibe: 3mm

Passierscheibe: 5mm



## Passiersieb

sieve strainer  
tamis passoire  
passino  
pasador  
passerzeef

Ø cm	Ø inch	Art.-Nr.	EAN
20,0	8	09 6601 28 20	4 007371 058094



## Gemüsebürste

vegetable brush  
brosse à légumes  
spazzolino per verdura  
cepillo para verdura  
groente-borstel

L/B/H cm	inch	Art.-Nr.	EAN
13,5 x 5,5 x 3,5	5½ x 2 x 1½	09 7350 10 00	4 007371 055734

Griff aus Buchenholz



## Champignonbürste

mushroom brush  
brosse à champignon  
spazzolino per funghi  
cepillo seta  
paddestoel-borstel

Ø cm	Ø inch	Art.-Nr.	EAN
4,5	2	09 7400 28 00	4 007371 042505

# Schönes und Nützliches

Die nützlichen Accessoires sind sowohl bei ambitionierten Hobbyköchen als auch beim Profi gleichermaßen gern gesehen. Attraktive Lunchboxen, praktische Löffelablagen und Papierrollenhalter für sauberes Arbeiten in der Küche.



# Praktische Küchenhelfer



## Lunchbox, anthrazit

lunchbox  
lunch box  
lunch box  
fiambrella  
lunch box

L/B/H cm	inch	Art.-Nr.	EAN
18,0 x 12,0 x 5,0	7x4½x2	10 0146 13 18	4 007371 057332
23,0 x 15,0 x 7,0	9x6x3	10 0147 13 23	4 007371 057356

Aluminium, mit Trennsteg  
Deckel mit Silikondichtung

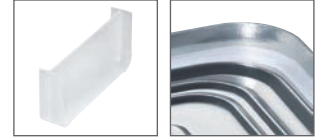

## Lunchbox, rot

lunchbox  
lunch box  
lunch box  
fiambrella  
lunch box

L/B/H cm	inch	Art.-Nr.	EAN
18,0 x 12,0 x 5,0	7x4½x2	10 0146 14 18	4 007371 056090
23,0 x 15,0 x 7,0	9x6x3	10 0147 14 23	4 007371 056113

Aluminium, mit Trennsteg  
Deckel mit Silikondichtung

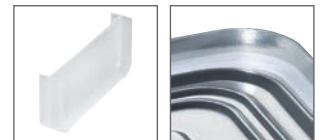

## Lunchbox, silber

lunchbox  
lunch box  
lunch box  
fiambrella  
lunch box

L/B/H cm	inch	Art.-Nr.	EAN
18,0 x 12,0 x 5,0	7x4½x2	10 0146 24 18	4 007371 056083
23,0 x 15,0 x 7,0	9x6x3	10 0147 24 23	4 007371 056106

Aluminium, mit Trennsteg  
Deckel mit Silikondichtung

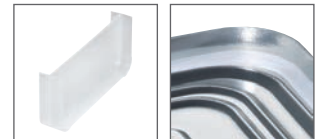

## Profi-Löffelablage

professional spoon rest  
porte cuillère profi  
portacucchiaio profi  
reposa cuchara profi  
profi lepel afdruijbordje

L/B/H cm	inch	Art.-Nr.	EAN
26,5 x 11,0 x 3,0	10½ x 4½ x 1	10 0222 28 00	4 007371 043106



## Kochlöffelständer

cooking spoon holder  
support de cuillère à pot  
appoggia mestolo  
reposa utensilios  
kooklepelboy

Ø cm	Höhe cm	Ø inch	Art.-Nr.	EAN
11,0	16,0	4½	10 0232 28 00	4 007371 033770

inklusive Porzellan-Schälchen und Holzlöffel



## Löffelablage

spoon rest  
porte cuillère  
portacucchiaio  
reposa cuchara  
lepel afdruijbordje

L/B/H cm	inch	Art.-Nr.	EAN
25,5 x 8,5 x 2,0	10 x 3 x 1	10 0234 28 00	4 007371 037235



# Praktische Küchenhelfer

Schönes und Nütliches



## Papierrollenhalter »Deluxe« mit Stopper

paper towel holder  
support papier de cuisine  
portarotoli tavolo  
soporte papel cocina  
keukenrolhouder

Ø cm	Höhe cm	Ø inch	Art.-Nr.	EAN
13,0	35,5	5	10 0236 28 00	4 007371 035736



## Papierrollenhalter mit Fixierfeder

paper towel holder  
support papier de cuisine  
portarotoli tavolo  
soporte papel cocina  
keukenrolhouder

Ø cm	Höhe cm	Ø inch	Art.-Nr.	EAN
17,0	32,5	6½	10 0239 28 00	4 007371 038522



## Papierrollenhalter »Style«

paper towel holder  
support papier de cuisine  
portarotoli tavolo  
soporte papel cocina  
keukenrolhouder

Ø cm	Höhe cm	Ø inch	Art.-Nr.	EAN
15,5	33,0	6	10 0241 28 00	4 007371 060646

VLBER  
DESIGN

## Papierrollenhalter

paper towel holder  
support papier de cuisine  
portarotoli tavolo  
soporte papel cocina  
keukenrolhouder

	Ø cm	Höhe cm	Ø inch	Art.-Nr.	EAN	GP
●	15,5	30,0	6	10 0750 10 00	4 007371 057738	
●	15,5	30,0	6	10 0750 11 00	4 007371 057745	
●	15,5	30,0	6	10 0750 14 00	4 007371 057752	
●	15,5	30,0	6	10 0750 22 00	4 007371 061124	



GP = Produkt in farbigem Geschenkkarton

KE = auf Karte mit Euroloch

# Würze und Co.

Frische Kräuter und Gewürze sind unerlässliche Zutaten, um Ihren Speisen eine besondere Note zu verleihen. Damit das Aroma voll zur Geltung kommt und den Geschmack der Gerichte unterstreicht finden Sie im KÜCHENPROFI- Sortiment passende Accessoires wie Mörser oder Wiegemesser.

Im KÜCHENPROFI Sortiment finden Sie hierfür die passenden Mörser aus Porzellan oder hochwertigem Marmor.

Mit den Essig-Sprühern und Öl-Spendern lassen sich Ihre Speisen wohldosiert verfeinern, besonders empfehlenswert für das ernährungsbewusste Kochvergnügen.



# Würze und Co.

Edelstahl rostfrei / stainless steel

Würze und Co.

## Gewürzgläser im Set



herb canister, 2 pcs.  
boîte à épices, 2 pcs  
barattolo per spezie, 2 pz.  
tarro especies, 2 pzs.  
kruidendoos, 2 stuks

Ø cm	Höhe cm	Inhalt ltr.	inch	Art.-Nr.	EAN	
5,5	10,0	2 x 0,125	2	10 0130 28 02	4 007371 044417	

Edelstahldeckel mit Silikonring

## Muskatmühle »New Orleans«



nutmeg mill  
moulin à muscade  
grattugia noce moscata  
molinillo nuez moscada  
nootmuskaatmolen

Ø cm	Höhe cm	Ø inch	Art.-Nr.	EAN	
10,0	10,5	4	10 0215 38 00	4 007371 051422	

Acryl / Chrom  
Mühle wird ohne Muskatnüsse geliefert

## Muskatmühle »Miami«



nutmeg mill  
moulin à muscade  
grattugia noce moscata  
molinillo nuez moscada  
nootmuskaatmolen

Ø cm	Höhe cm	Ø inch	Art.-Nr.	EAN	
5,0	21,0	2	10 0216 10 00	4 007371 058018	

Kunststoff / Edelstahl  
Mühle wird ohne Muskatnüsse geliefert

## Muskatmühle »Deluxe«



nutmeg mill  
moulin à muscade  
grattugia noce moscata  
molinillo nuez moscada  
nootmuskaatmolen

Ø cm	Höhe cm	Ø inch	Art.-Nr.	EAN	
8,5	9,0	3½	10 0220 66 00	4 007371 026802	

Acryl / Chrom  
Mühle wird ohne Muskatnüsse geliefert

## Muskatreibe »Classic«



nutmeg grater  
râpe à muscade  
grattugia noce moscata  
rallador nuez moscada  
nootmuskaatrasp

Länge cm	inch	Art.-Nr.	EAN	
15,0	6	10 0230 28 00	4 007371 027984	

## Tisch-Feinstreuer, mit Aromaschutzhaube



fine dredger  
saupoudreur à filet  
spargitutto fino  
esparcidor fino  
fijne strooier

Ø cm	Höhe cm	Inhalt ltr.	inch	Art.-Nr.	EAN	
6,0	8,0	0,2	3	10 0307 28 00	4 007371 026451	

## Tisch-Grobstreuer, mit Aromaschutzhaube



coarse dredger  
saupoudreur à gros  
spargitutto grosso  
esparcidor grueso  
grove strooier

Ø cm	Höhe cm	Inhalt ltr.	inch	Art.-Nr.	EAN	
6,0	8,0	0,2	3	10 0308 28 00	4 007371 026468	

## Tisch-Netzstreuer, mit Aromaschutzhaube



net dredger  
saupoudreur à filet  
spargitutto a rete  
esparcidor de red  
cacaostrooier

Ø cm	Höhe cm	Inhalt ltr.	inch	Art.-Nr.	EAN	
6,0	8,0	0,2	3	10 0309 28 00	4 007371 026475	



# Mörser-Kollektion

Marmor / Porzellan



## Mörser Marmor

mortar marble  
mortier marbre  
mortaio marmo  
mortero  
vijzel marmer

Ø cm	Höhe cm	Ø inch	Art.-Nr.	EAN	GP
9,5	4,5	3½	10 0243 08 08	4 007371 018937	
11,0	7,0	4½	10 0243 08 11	4 007371 018944	



## Mörser Marmor, schwarz

mortar marble  
mortier marbre  
mortaio marmo  
mortero  
vijzel marmer

Ø cm	Höhe cm	Ø inch	Art.-Nr.	EAN	GP
11,0	7,0	4½	10 0243 10 11	4 007371 039765	



## Mörser Marmor mit Fuß

mortar marble  
mortier marbre  
mortaio marmo  
mortero  
vijzel marmer

Ø cm	Höhe cm	Ø inch	Art.-Nr.	EAN	GP
12,0	11,5	4¾	10 0250 08 12	4 007371 033695	



## Mörser Marmor »Trento«

mortar marble  
mortier marbre  
mortaio marmo  
mortero  
vijzel marmer

Ø cm	Höhe cm	Ø inch	Art.-Nr.	EAN	GP
14,5	7,5	5¾	10 0253 08 15	4 007371 056892	



## Mörser Porzellan

porcelain mortar  
mortier en porcelaine  
mortaio porcellana  
mortero porcelana  
vijzel porselein

Ø cm	Höhe cm	Ø inch	Art.-Nr.	EAN	GP
7,0	4,0	3	10 0673 82 07	4 007371 048828	
9,0	5,0	3½	10 0673 82 09	4 007371 020619	
12,0	6,5	4¾	10 0673 82 12	4 007371 020626	
14,0	8,0	5¾	10 0673 82 14	4 007371 048835	
16,0	9,0	6¾	10 0673 82 16	4 007371 057684	



# Würze und Co.

Edelstahl rostfrei / stainless steel

Würze und Co.



## Essig-Sprüher & Öl-Spender »Tavola« im Set, matt

vinegar sprayer & oil dispenser  
vaporisateur de vinaigre &  
distributeur d'huile  
vaporizzatore aceto & porzionatore olio  
vaporizador vinagre & porcinador aceite  
azijn-verstuiver & oliepom

Ø cm	Höhe cm	Inhalt ltr.	inch	Art.-Nr.	EAN	
3,8	19,0	0,11	1½	10 0506 28 11	4 007371 044479	



## Olivenölsprüher »Mephisto«, matt

olive oil sprayer  
vaporisateur d'huile d'olive  
vaporizzatore olio de oliva  
vaporizador aceite de oliva  
olijfolie-verstuiver

Ø cm	Höhe cm	Inhalt ltr.	inch	Art.-Nr.	EAN	
5,0	19,0	0,2	2	10 0507 28 00	4 007371 038492	

mit Pumpmechanismus



## Essig-Sprüher & Öl-Spender »Trattoria«, matt

vinegar sprayer & oil dispenser  
vaporisateur de vinaigre &  
distributeur d'huile  
vaporizzatore aceto & porzionatore olio  
vaporizador vinagre & porcinador aceite  
azijn-verstuiver & oliepom

Ø cm	H cm	Inhalt ltr.	inch	Art.-Nr.	EAN	
Essig:						
5,0	19,0	0,2	2	10 0530 28 20	4 007371 044486	
Öl:						
5,0	19,0	0,2	2	10 0531 28 20	4 007371 044493	



## Wiegemesser, 2-schneidig

mincing knife double  
hachoir berceuse double  
mezzaluna 2 lame  
cuchillo picar 2 hojas  
wiegemes

Klingenlänge cm	inch	Art.-Nr.	EAN	
17,0	7	10 0517 28 00	4 007371 044110	



## Gemüseschäler »2in1«

vegetable peeler  
éplucheur végétale  
pela verdura  
pela verduras  
dunschiller

Klingenlänge cm	inch	Art.-Nr.	EAN	
4,5	2	10 0520 28 00	4 007371 041720	

mit zwei Pendelklingen: Sparschäler & Julienne-Schäler,  
für Links- und Rechtshänder

36 Stück im attraktiven Verkaufs-Display



## Gemüseschäler, längs

vegetable peeler  
éplucheur végétale  
pela verdura  
pela verduras  
dunschiller

Klingenlänge cm	inch	Art.-Nr.	EAN	
5,0	2	10 0521 28 00	4 007371 057226	

für Links- und Rechtshänder  
Gesamtlänge 16,5 cm



## Gemüseschäler, quer

vegetable peeler  
éplucheur végétale  
pela verdura  
pela verduras  
dunschiller

Klingenlänge cm	inch	Art.-Nr.	EAN	
5,0	2	10 0522 28 00	4 007371 057233	

für Links- und Rechtshänder  
Gesamtlänge 12,0 cm



# Spargel

Vom handlichen Spargelschäler für das mühelose Vorbereiten über Spargelkocher zur perfekten Zubereitung des Gemüses bis zum Butterpfännchen mit passendem Rechaud für das stilechte Anrichten bei Tisch lässt das KÜCHENPROFI – Sortiment keine Wünsche offen.





# Spargel

Edelstahl rostfrei / stainless steel

Spargel



## Spargelkocher »Siena«

asparagus pot  
cuit-vapeur à asperges  
cuoci asparagi  
hervidor espárragos  
aspergepan

Ø cm	Höhe cm	Inhalt ltr.	inch	Art.-Nr.	EAN
16,0	23,0	4,0	6½	<b>10 3001 28 16</b>	4 007371 027892

mit Edelstahleinsatz, Sandwichboden, Glasdeckel  
geeignet für Elektro, Gas, Glaskeramik, Induktion



## Spargelschäler

asparagus peeler  
éplucheur à asperges  
pela asparagi  
pela esparragos  
aspergeschiller

Länge cm	inch	Art.-Nr.	EAN
16,0	6½	<b>10 3002 28 00</b>	4 007371 033589

auch für Möhren geeignet / für Links- und Rechtshänder  
**24 Stück im attraktiven Verkaufs-Display**



## Gemüse-/ Spargelschäler mit 2 Klingen

asparagus peeler  
éplucheur à asperges  
pela asparagi  
pela esparragos  
aspergeschiller

Länge cm	inch	Art.-Nr.	EAN
17,0	6½	<b>10 3003 28 00</b>	4 007371 058971

auch für Möhren geeignet / für Links- und Rechtshänder  
**24 Stück im attraktiven Verkaufs-Display**



**><<>**  
Kurz Kurz Design



## Butterpfännchen

saucepan  
casserole à beurre  
pentolino per burro  
cazo salsa  
boterpannetje

Ø cm	Höhe cm	Inhalt ltr.	inch	Art.-Nr.	EAN
10,0	4,2	0,2	4	<b>10 3578 28 10</b>	4 007371 014205

## Rechaud für Butterpfännchen

warmer for saucepan  
rechaud pour casserole  
fornello per pentolino  
calentador para cazo salsa  
rechaud voor boterpannetje

Ø cm	Höhe cm	Ø inch	Art.-Nr.	EAN
10,0	6,0	4	<b>10 3600 28 00</b>	4 007371 019484



## Butterpfännchen

butter melter  
casserole à beurre  
pentolino per burro  
cazo salsa  
boterpannetje

Ø cm	Inhalt ltr.	Ø inch	Art.-Nr.	EAN
10,0	0,25	4	<b>23 7000 28 10</b>	4 007371 051569
12,0	0,5	4	<b>23 7000 28 12</b>	4 007371 051576

mit Innenskala  
geeignet für **Induktion**  
(abhängig vom Mindestdurchmesser der Topferkennung)

**GP** = Produkt in farbigem Geschenkkarton

**KE** = auf Karte mit Euroloch

# Reibenvielfalt

Wer Wert auf eine gesunde, frische Ernährung legt, benötigt auch gute Küchengeräte. Das Reiben-Sortiment von KÜCHENPROFI bietet unentbehrliche Helfer für schmackhafte Gerichte. Ob fein geraspelte Rohkost, gleichmäßige Kartoffelscheiben oder geriebener Käse für den Auflauf – KÜCHENPROFI wird jedem Anspruch gerecht.



# Reiben

Edelstahl rostfrei / stainless steel

Reibenvielfalt



## Reibe »Quadro«

box grater, 4-sided  
râpe à 4 faces  
grattugia quadra  
rallador 4 ángulos  
4-kantige rasp

Höhe cm	inch	Art.-Nr.	EAN
18,5	7½	10 0440 28 00	4 007371 043861

mit Grob-, Fein- und Kronenreibe sowie Gurkenhobel



## Reibe »Quadro«

box grater, 4-sided  
râpe à 4 faces  
grattugia quadra  
rallador 4 ángulos  
4-kantige rasp

Höhe cm	inch	Art.-Nr.	EAN
25,0	10	10 0445 28 00	4 007371 043878

mit Grob-, Fein- und Kronenreibe sowie Gurkenhobel



## 4-Kant-Reibe »Profi«

box grater 4-sided  
râpe à 4 faces  
grattugia quadra  
rallador 4 ángulos  
4-kantige rasp

Höhe cm	inch	Art.-Nr.	EAN
24,0	4	10 0509 28 00	4 007371 053662

Zester fein/grob, Raspel, Grobreibe und Gurkenhobel  
Messerscharfe Klingen durch moderne Ätztechnik



## 4-Kant-Reibe

small box grater, 4-sided  
râpe à 4 faces  
grattugia quadra  
rallador 4 ángulos  
4-kantige rasp

Höhe cm	inch	Art.-Nr.	EAN
21,5	8½	10 0510 28 00	4 007371 025065

mit Grob-, Fein- und Kronenreibe sowie Gurkenhobel



## Jumbo 4-Kant-Reibe

large box grater, 4-sided  
râpe à 4 faces géante  
grattugia jumbo quadra  
rallador 4 ángulos jumbo  
jumbo 4-kantige rasp

Höhe cm	inch	Art.-Nr.	EAN
23,5	9½	10 0512 28 00	4 007371 026574

mit Grob-, Fein- und Kronenreibe sowie Gurkenhobel



GP = Produkt in farbigem Geschenkkarton



KE = auf Karte mit Euroloch



# Reiben

Edelstahl rostfrei / stainless steel

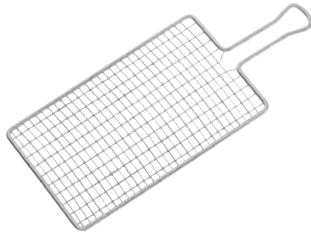

## Kartoffelreibe

potato grater  
râpe a pomme de terre  
grattugiapatate  
rallador patatas  
ardappelrasp

L/B cm	inch	Art.-Nr.	EAN
32,0 x 13,0	12½ x 5	10 2008 28 00	4 007371 039406



## Gurkenhobel »Fix«, hochwertiger Kunststoff

cucumber slicer  
râpe à concombres  
grattugia cetriolo  
cortador pepinos  
komkommerrasp

L/B cm	inch	Art.-Nr.	EAN
27,5 x 11,0	11 x 4½	10 2013 22 00	4 007371 045902

mit extra scharfer Klinge und rutschfester Auflage



## Zweifachhobel

double slicer  
rabot légumes  
affetta verdure  
corta verduras  
groente schaaf

L/B cm	inch	Art.-Nr.	EAN
33,0 x 12,0	13 x 4¾	13 1087 22 00	4 007371 052986

für Scheiben und Julienne



## Gemüsehobel »Professional«

vegetable slicer  
râpe à légumes  
affetta  
cortador vegetales  
groentenschaaf

L/B/H cm	inch	Art.-Nr.	EAN
43,5 x 11,5 x 14,0	17 x 4½ x 5½	09 0043 10 00	4 007371 056052

mit Resthalter  
5 Schneideinsätze für Scheiben (1,5 mm / 2,5 mm / 3,5 mm) und Streifen (3,5 mm / 7,5 mm)  
rutschfeste Füße für sicheres Arbeiten

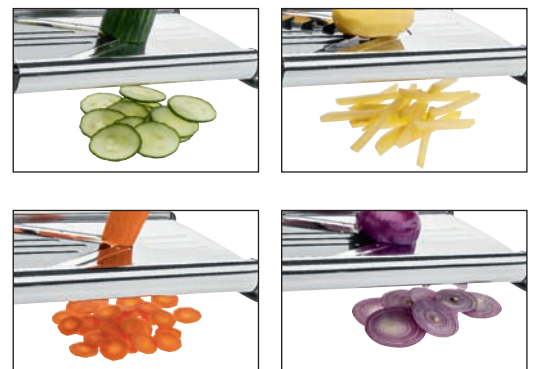

# Reiben

Edelstahl rostfrei / stainless steel



- spülmaschinenfest
- Design: Ralph Krämer

Art.-Nr.	EAN
<b>12 3001 28 00</b>	4 007371 050760

L/B/H cm	inch
<b>32,0 x 6,5 x 1,5</b>	<b>12½ x 2½ x ⅝</b>

Reibfläche: 13,5 x 5,5 cm



Reibbild, Darstellung 1:1

## Reibe fein

fine grater  
râpe à fin  
grattugia, fine  
rallador en fino  
rasp, fijn



Messerscharfe Klingen durch moderne Ätztechnik  
Rutschfester Silikonfuß für sicheren Stand



Reibbild, Darstellung 1:1

## Reibe grob

coarse grater  
râpe à gros  
grattugia, grosso  
rallador en grueso  
rasp, grof

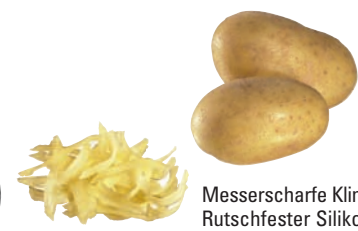

Messerscharfe Klingen durch moderne Ätztechnik  
Rutschfester Silikonfuß für sicheren Stand

Art.-Nr.	EAN
<b>12 3002 28 00</b>	4 007371 050777

L/B/H cm	inch
<b>32,0 x 6,5 x 1,5</b>	<b>12½ x 2½ x ⅝</b>

Reibfläche: 13,5 x 5,5 cm

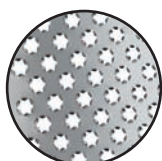

Reibbild, Darstellung 1:1

## Kronenreibe

crown grater  
râpe couronnes  
grattugia corona  
rallador corona  
kroon rasp



Messerscharfe Klingen durch moderne Ätztechnik  
Rutschfester Silikonfuß für sicheren Stand

Art.-Nr.	EAN
<b>12 3003 28 00</b>	4 007371 050784

L/B/H cm	inch
<b>32,0 x 6,5 x 1,5</b>	<b>12½ x 2½ x ⅝</b>

Reibfläche: 13,5 x 5,5 cm



## Restehalter zur Reiben-Serie »Classic«

hand guard  
poussoir-garde  
fermaresti  
empujador de seguridad  
resthouder

Art.-Nr.	EAN
<b>12 3000 10 00</b>	4 007371 050753



- spülmaschinenfest
- Design: Ralph Krämer

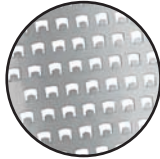

Reibbild, Darstellung 1:1



Messerscharfe Klingen durch moderne Ätztechnik  
Rutschfester Silikonfuß für sicheren Stand

**Zester fein**

fine zester  
zesteur à fin  
grattugia fine  
rallador zester, fino  
rasp, fijn

Art.-Nr.	EAN
<b>12 3005 28 00</b>	4 007371 050807

L/B/H cm	inch
32,0 x 6,5 x 1,5	12½ x 2½ x ⅝

Reibfläche: 13,5 x 5,5 cm

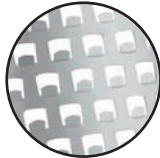

Reibbild, Darstellung 1:1



Messerscharfe Klingen durch moderne Ätztechnik  
Rutschfester Silikonfuß für sicheren Stand

**Zester grob**

coarse zester  
zesteur à gros  
grattugia grossa  
rallador zester, grueso  
rasp, grof

Art.-Nr.	EAN
<b>12 3006 28 00</b>	4 007371 050814

L/B/H cm	inch
32,0 x 6,5 x 1,5	12½ x 2½ x ⅝

Reibfläche: 13,5 x 5,5 cm



**Resthalter zur Reiben-Serie »Classic«**

hand guard  
poussoir-garde  
fermaresti  
empujador de seguridad  
resthouder

Art.-Nr.	EAN
<b>12 3000 10 00</b>	4 007371 050753

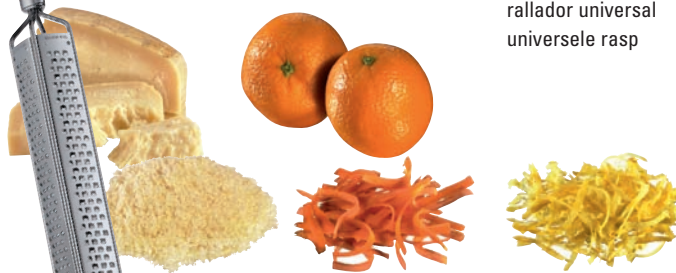

Messerscharfe Klingen durch moderne Ätztechnik  
Rutschfester Silikonfuß für sicheren Stand

**Multi-Reibe »Parma Gourmet«**

all-purpose grater  
râpe universelle  
grattugia universale  
rallador universal  
universele rasp

Art.-Nr.	EAN
<b>12 3007 28 00</b>	4 007371 057905

Länge cm	inch
40,0	16⅝

Kronenreibe, Zester fein, Zester grob  
Reibfläche: 22,0 x 3,0 cm



# Reiben

Edelstahl rostfrei / stainless steel



■ spülmaschinenfest  
■ Design: Ralph Krämer

PARMA Reiben & more



Reibbild, Darstellung 1:1



Messerscharfe Klingen durch moderne Ätztechnik  
Rutschfester Silikonfuß für sicheren Stand

## Zester fein

fine zester  
zesteur à fin  
grattugia fine  
rallador zester, fino  
rasp, fijn

Art.-Nr.	EAN
<b>12 3105 28 00</b>	4 007371 050838

L/B/H cm	inch
40,0 x 3,5 x 1,5	15½ x 1⅓ x ⅝

Reibfläche: 22,0 x 3,0 cm



Reibbild, Darstellung 1:1



Messerscharfe Klingen durch moderne Ätztechnik  
Rutschfester Silikonfuß für sicheren Stand

## Zester grob

coarse zester  
zesteur à gros  
grattugia grossa  
rallador zester, grueso  
rasp, grof

Art.-Nr.	EAN
<b>12 3106 28 00</b>	4 007371 050845

L/B/H cm	inch
40,0 x 3,5 x 1,5	15½ x 1⅓ x ⅝

Reibfläche: 22,0 x 3,0 cm

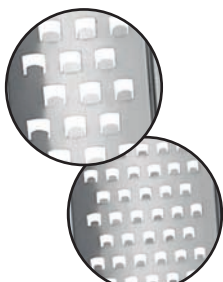

Reibbild, Darstellung 1:1



Messerscharfe Klingen durch moderne Ätztechnik  
Rutschfester Silikonfuß für sicheren Stand

## Zester fein + grob

fine / coarse zester  
zesteur à fin / gros  
grattugia fine / grossa  
rallador zester fino / grueso  
rasp, fijn / grof

Art.-Nr.	EAN
<b>12 3107 28 00</b>	4 007371 050852

L/B/H cm	inch
40,0 x 3,5 x 1,5	15½ x 1⅓ x ⅝

Reibfläche: 22,0 x 3,0 cm



## Restehalter zur Reiben-Serie »Gourmet«

hand guard  
poussoir-garde  
fermaresti  
empujador de seguridad  
resthouder

Art.-Nr.	EAN
<b>12 3100 10 00</b>	4 007371 050821



■ spülmaschinenfest



Reibbild, Darstellung 1:1



Messerscharfe Klingen durch moderne Ätztechnik

**Zester fein**

fine zester  
zesteur à fin  
grattugia fine  
rallador zester, fino  
rasp, fijn

Art.-Nr.	EAN
<b>12 3205 28 00</b>	4 007371 050869

L/B/H cm	inch
33,0 x 3,5 x 1,5	15 1/8 x 1 1/8 x 3/8

Reibfläche: 20,5 x 2,5 cm



Reibbild, Darstellung 1:1



Messerscharfe Klingen durch moderne Ätztechnik

**Zester grob**

coarse zester  
zesteur à gros  
grattugia grossa  
rallador zester, grueso  
rasp, grof

Art.-Nr.	EAN
<b>12 3206 28 00</b>	4 007371 050876

L/B/H cm	inch
33,0 x 3,5 x 1,5	15 1/8 x 1 1/8 x 3/8

Reibfläche: 20,5 x 2,5 cm

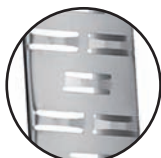

Reibbild, Darstellung 1:1



Messerscharfe Klingen durch moderne Ätztechnik

**Raspel**

rasp medium ribbon  
râpe  
grattugia media  
rallador medio  
rasp medium

Art.-Nr.	EAN
<b>12 3208 28 00</b>	4 007371 050883

L/B/H cm	inch
33,0 x 3,5 x 1,5	15 1/8 x 1 1/8 x 3/8

Reibfläche: 20,5 x 2,5 cm



# Reiben

Edelstahl rostfrei / stainless steel

Reibenvielfalt



## Standreibe, klappbar

collapsible grater  
râpe pliante  
grattugia a scala, apribile  
rallador plegable  
staande rasp, inklapbaar

L/B/H cm	inch	Art.-Nr.	EAN	
24,0 x 8,0 x 2,5	9½ x 3 x 1	<b>12 3500 28 00</b>	4 007371 050890	

messerscharfe Klingen durch moderne Ätztechnik  
rutschfeste Silikonfüße für sicheren Stand

Reibfläche: 15,5 x 8 cm



## Gurkenhobel »Profi«

cucumber slicer  
râpe à concombres  
grattugia cetriolo  
cortador pepinos  
komkommerrasp

L/B/H cm	inch	Art.-Nr.	EAN	
27,0 x 9,5 x 2,0	10½ x 3¾ x ¾	<b>12 3604 28 00</b>	4 007371 052771	

Reibfläche: 15,5 x 8 cm



## Universalreibe »Profi«

all-purpose grater  
râpe universelle  
grattugia universale  
rallador universal  
universele rasp

L/B/H cm	inch	Art.-Nr.	EAN	
27,0 x 9,5 x 2,0	10½ x 3¾ x ¾	<b>12 3610 28 00</b>	4 007371 052795	

Reibfläche: 15,5 x 8 cm



## Finger-Schneidschutz

finger protector  
protège-doigts  
proteggi dita  
protector para los dedos  
vinger-snijbeschermer

L/B/H cm	inch	Art.-Nr.	EAN	
19,0 x 6,5 x 2,5	7½ x 2½ x 1	<b>12 2900 28 00</b>	4 007371 055086	

18 Stück im attraktiven Verkaufs-Display



## Muskat-/Gewürzreibe, mit Behälter

nutmeg/spice grater  
râpe à épices  
grattugia per spezie  
rallador de especias  
muskaat-kruidenrasp

L/B/H cm	inch	Art.-Nr.	EAN	
7,5 x 5,0 x 3,0	3 x 2 x 1	<b>12 3550 28 00</b>	4 007371 051866	

24 Stück im attraktiven Verkaufs-Display



# Reiben

Edelstahl rostfrei / stainless steel

## Käsereibe

cheese grater  
râpe à fromage  
grattugia per formaggio  
rallador queso  
kaasrasp



Länge cm	inch	Art.-Nr.	EAN	GP
20,0	7¾	13 1021 28 00	4 007371 032261	

## Käsereibe elektrisch, mit 2 Trommeln

cheese grater electric  
râpe à fromage électrique  
grattugia per formaggio elettrica  
rallador de queso eléctrico  
electrische kaasrasp



L/B/H cm	inch	Art.-Nr.	EAN	GP
26,5 x 9,5 x 10,5	10½ x 3¾ x 4	13 9000 14 00	4 007371 060707	
26,5 x 9,5 x 10,5	10½ x 3¾ x 4	13 9000 77 00	4 007371 060714	

für Parmesan, andere Hartkäsesorten, Nüsse und Schokolade  
Inklusive Akku, Ladegerät, 2 Reibtrommeln und Bedienungsanleitung

### Technische Daten

Ladegerät:

Eingang: 230 V ~ 50 Hz / Ausgang: 5 Vdc 300 mA

Akku: 3,6 Vdc 800 mAh



# Timer

Im Alltagsstress verliert man schnell den Überblick. Doch jetzt verpassen Sie den richtigen Moment nicht mehr. Sei es das sonntägliche Frühstücksei oder der grüne Tee, die mit den zuverlässigen Timern immer perfekt gelingen.



# Küchentimer



## Timer »Peppino«

timer  
minuteur  
contaminuti  
timer  
kookwekker

Ø cm	Höhe cm	Ø inch	Art.-Nr.	EAN
6,0	10,0	2½	10 0905 00 00	4 007371 027380

60 Minuten-Timer



## Timer »Pluto«

timer  
minuteur  
contaminuti  
timer  
kookwekker

Ø cm	Höhe cm	Ø inch	Art.-Nr.	EAN
6,5	6,0	2½	10 0919 28 00	4 007371 050111

60 Minuten-Timer



## Timer »Planet«

timer  
minuteur  
contaminuti  
timer  
kookwekker

Ø cm	Höhe cm	Ø inch	Art.-Nr.	EAN
9,5	6,0	3¾	10 0923 28 00	4 007371 045728

60 Minuten-Timer



## Timer »Planet«

timer  
minuteur  
contaminuti  
timer  
kookwekker

Ø cm	Höhe cm	Ø inch	Art.-Nr.	EAN
9,5	6,0	3¾	10 0923 10 00	4 007371 060042

60 Minuten-Timer



## Timer »Planet«

timer  
minuteur  
contaminuti  
timer  
kookwekker

Ø cm	Höhe cm	Ø inch	Art.-Nr.	EAN
9,5	6,0	3¾	10 0923 14 00	4 007371 060059

60 Minuten-Timer



## Timer »Planet«

timer  
minuteur  
contaminuti  
timer  
kookwekker

Ø cm	Höhe cm	Ø inch	Art.-Nr.	EAN
9,5	6,0	3¾	10 0923 22 00	4 007371 060066

60 Minuten-Timer



# Küchentimer

Timer und andere Helfer



## Timer »Egg«

timer  
minuteur  
contaminuti  
timer  
kookwekker

Ø cm	Höhe cm	Ø inch	Art.-Nr.	EAN	
6,0	8,0	3	10 0924 28 00	4 007371 045889	

60 Minuten-Timer



## Timer »Egg«

timer  
minuteur  
contaminuti  
timer  
kookwekker

Ø cm	Höhe cm	Ø inch	Art.-Nr.	EAN	
6,0	8,0	3	10 0924 10 00	4 007371 055574	

60 Minuten-Timer



## Timer »Egg«

timer  
minuteur  
contaminuti  
timer  
kookwekker

Ø cm	Höhe cm	Ø inch	Art.-Nr.	EAN	
6,0	8,0	3	10 0924 11 00	4 007371 055581	

60 Minuten-Timer



## Timer »Egg«

timer  
minuteur  
contaminuti  
timer  
kookwekker

Ø cm	Höhe cm	Ø inch	Art.-Nr.	EAN	
6,0	8,0	3	10 0924 14 00	4 007371 055598	

60 Minuten-Timer



## Timer »Egg perfect«

timer  
minuteur  
contaminuti  
timer  
kookwekker

L/ B cm	inch	Art.-Nr.	EAN	
6,0 x 4,0	2½ x 1½	10 0925 00 00	4 007371 042017	

18 Stück im attraktiven Verkaufs-Display



# Küchentimer

## Sanduhr »Tea Time«, 3-teilig



sandglass  
sablier  
clessidra  
reloj  
sandloper

Höhe cm	inch	Art.-Nr.	EAN
8,0	3	10 0926 00 00	4 007371 051552

für 3 Minuten (grün), 5 Minuten (schwarz) und 7 Minuten (rot)

## Digitaltimer »4times«



timer  
minuteur  
contaminuti  
timer  
kookwekker

L/B/H cm	inch	Art.-Nr.	EAN
8,5 x 8,5 x 4,0	3 3/8 x 3 3/8 x 1 1/2	10 0927 00 00	4 007371 051637

überwacht bis zu 4 verschiedene Zeiten

## Sand / Eieruhr, 3-teilig



sandglass  
sablier  
clessidra  
reloj  
sandloper

Höhe cm	inch	Art.-Nr.	EAN
8,0	3	10 0928 00 00	4 007371 058315

für 4 Minuten (gelb), 5 Minuten (schwarz) und 6 Minuten (orange)





# Braten

Zartes Fleisch, würzige Marinade und cremige Saucen – das sind die Zutaten für einen köstlichen Braten.







Die nötigen Accessoires für ein perfektes Ergebnis kommen von KÜCHENPROFI – Rouladenklammern oder Küchengarn für eine schöne Form, Bratenthermometer für die richtige Kerntemperatur und Ofenhandschuhe für ausreichenden Schutz.



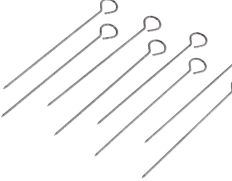
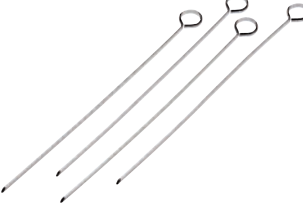

# Braten

Edelstahl rostfrei / stainless steel

	<b>Rouladenklammern, 6 Stück im Set</b>	L/B cm 10,0 x 4,0	inch 4 x 1½	Art.-Nr. <b>09 2401 28 06</b>	EAN 4 007371 057028	meat clamp pince à roulades ganci per involtini pinzas para rollos de carne rellenos rolladeklemmen
	<b>Rouladenringe, 6 Stück im Set</b>	Ø cm 4,5 – 5,5	Ø inch 1¾	Art.-Nr. <b>09 2402 28 06</b>	EAN 4 007371 057035	roulade rings boucle à roulades anello per involtini rollas de carne rellenos rollade ring
	<b>Rouladennadeln, 10 Stück im Set</b>	Länge cm 10,0	inch 4	Art.-Nr. <b>09 2403 28 10</b>	EAN 4 007371 057042	roulade needles aiguilles à roulades agni per involtini aros fijadores para rollos de carne rollade naalden
	<b>Gourmetspieße, 4 Stück im Set</b>	Länge cm 20,5	inch 8	Art.-Nr. <b>09 2404 28 04</b>	EAN 4 007371 057059	gourmet skewers broches gourmet spiedi per gourmet pinchos para gourmet gourmet spies
	<b>Spicknadel</b>	Länge cm 19,5	inch 7½	Art.-Nr. <b>09 2405 28 00</b>	EAN 4 007371 058025	larding needle lardoire ago per lardellare mechador lardeernaald
	<b>Kordelbox »Küchengarn«, mit Schneidevorrichtung</b>	Ø cm Höhe cm 7,0 7,5	Ø inch 2½	Art.-Nr. <b>09 2500 00 00</b>	EAN 4 007371 040327	cord box cordelette en boîte spago per la cucina caja hilo cocina keukengaren inklusive 50m lebensmittelechtem Garn
	<b>Kordelbox »Küchengarn«, mit Schneidevorrichtung</b>	Ø cm Höhe cm 8,0 8,0	Ø inch 3	Art.-Nr. <b>09 2550 00 00</b>	EAN 4 007371 031370	cord box cordelette en boîte spago per la cucina caja hilo cocina keukengaren inklusive 50m lebensmittelechtem Garn
	<b>Kordelbox »Wurstgarn«, mit Schneidevorrichtung</b>	Ø cm Höhe cm 8,0 8,0	Ø inch 3	Art.-Nr. <b>09 2560 00 00</b>	EAN 4 007371 050203	cord box cordelette en boîte spago per la cucina caja hilo cocina keukengaren inklusive 50m lebensmittelechtem Garn

 GP = Produkt in farbigem Geschenkkarton

 KE = auf Karte mit Euroloch

# Braten

Edelstahl rostfrei / stainless steel

	Ø cm	Höhe cm	Inhalt ltr.	inch	Art.-Nr.	EAN	
<b>Fett-Trennkanne</b> fat separator jug verseuse graduée gras/maigre versatore grasso/magro jarra separadora de grasas kan met vetafscheider	11,0	16,0	1,0	4½	<b>10 1236 28 00</b>	4 007371 047623	

Edelstahl/Glas



	Länge cm	inch	Art.-Nr.	EAN	
<b>Ofenhandschuh kurz, 2 Stück im Set</b> oven gloves gants de four guanti da forno guantes para horno ovenhandschoenen	23,0	9	<b>10 6000 22 23</b>	4 007371 057943	

waschbar bei 40°C, geschmeidig, hitzebeständig und schwer entflammbar, mit Baumwolle gefüttert. 350°C Hitzeschutz



	Länge cm	inch	Art.-Nr.	EAN	
<b>Ofenhandschuh lang, 2 Stück im Set</b> oven gloves gants de four guanti da forno guantes para horno ovenhandschoenen	39,0	15½	<b>10 6000 22 39</b>	4 007371 057950	

waschbar bei 40°C, geschmeidig, hitzebeständig und schwer entflammbar, mit Baumwolle gefüttert. 350°C Hitzeschutz



	Länge cm	inch	Art.-Nr.	EAN	
<b>Topfhandschuh »Apollo«</b> oven mitt gant de cuisine guanto forno manopla horno keukenwant	30,0	11¾	<b>10 6100 00 00</b>	4 007371 032278	

hitzeisoliert, auch für Grill und Backofen



	Länge cm	inch	Art.-Nr.	EAN	
<b>Braten- / Gewürzspritze</b> baster set seringue à épices pompetta per arrostiti set para rustidos kruiden-injector voor braadvlees	31,0	12	<b>10 6300 28 00</b>	4 007371 034272	

inklusive Reinigungsbürste



	Länge cm	inch	Art.-Nr.	EAN	
<b>Gewürz- &amp; Marinaden-spritze »Spicy«</b> gourmet marinade injector seringue à épices siringa per arrostiti jeringa para rustidos pipet/bedruijsput	25,0	10	<b>10 6360 28 00</b>	4 007371 057998	

inklusive 2 Nadeln, 3,5 mm und 5 mm



GP = Produkt in farbigem Geschenkkarton

KE = auf Karte mit Euroloch

# Thermometer

Edelstahl rostfrei / stainless steel



## Braten-Thermometer

roast thermometer  
thermomètre à rôti  
termometro per arrosti  
termómetro para asados  
braadthermometer

Ø cm	Höhe cm	Ø inch	Art.-Nr.	EAN	GP
11,0	5,5	4½	10 6500 28 00	4 007371 037044	

Skala: 0° – 120°C

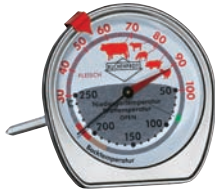

## Kombi-Thermometer, Braten/Ofen

roast / oven thermometer  
thermomètre pour le four / à rôti  
termometro per forno / arrosti  
termómetro para el horno / asados  
oven / braad thermometer

L/B/H cm	inch	Art.-Nr.	EAN	GP
7,0 x 7,5 x 14,0	2¾ x 3 x 5½	10 6505 28 00	4 007371 053099	

Skala Braten: 30°C – 100°C  
Skala Ofen: 50°C – 250°C  
Messfühler: 11,5 cm



## Backofen-Thermometer

oven thermometer  
thermomètre pour le four  
termometro per forno  
termómetro para el horno  
oven thermometer

Ø cm	Ø inch	Art.-Nr.	EAN	GP
7,5	3	10 6510 28 00	4 007371 041997	

Skala: 50° – 300°C,  
auch zum Hängen geeignet



## Kühlschrank-Thermometer

refrigerator thermometer  
thermomètre de réfrigérateur  
termometro per frigorifero  
termómetro para la nevera frigorifera  
koelkast thermometer

Ø cm	Ø inch	Art.-Nr.	EAN	GP
7,5	3	10 6520 28 00	4 007371 042000	

Skala: -30° bis + 30°C, auch für Gefrierschrank  
auch zum Hängen geeignet



## Digitales Braten-thermometer »Easy«

roast thermometer  
thermomètre à rôti  
termometro per arrosti  
termómetro para asados  
braadthermometer

L/B/H cm	inch	Art.-Nr.	EAN	GP
6,5 x 9,5 x 2,5	2½ x 3¾ x 1	10 6504 00 00	4 007371 058759	

Umschaltbar °C/°F  
Messbereich: 0°C bis 250°C  
inklusive Batterie und Bedienungsanleitung



## Digitales Braten-thermometer »Profi«

roast thermometer  
thermomètre à rôti  
termometro per arrosti  
termómetro para asados  
braadthermometer

L/B/H cm	inch	Art.-Nr.	EAN	GP
7,0 x 1,5 x 11,5	2¾ x ½ x 4½	10 6568 00 00	4 007371 052108	

mit Funkübertragung (Reichweite bis 30m)



## Frittier-Thermometer

deep fry thermometer  
thermomètre pour le friture  
termometro per friggere  
termómetro para freír  
frituurthermometer

Ø cm	L cm	Ø inch	Art.-Nr.	EAN	GP
5,5	21,0	2	10 6508 28 00	4 007371 060691	



# Kaffee- und Tee-Accessoires

Dampfender Kaffee mit einer Haube aus cremigem Milchschaum oder doch lieber eine Tasse Tee?

Egal wie Sie sich entscheiden, immer garantieren hochwertige Materialien, ansprechende Designs und langlebige Verarbeitung vollendeten Genuss.



## Tea-Boy Pinguin

mit Präzisions-Timer

Höhe cm	inch	Art.-Nr.	EAN
20,0	8	31 1000 00 00	4 007371 034579



hebt nach Ablauf der eingestellten Zeit den Teebeutel aus der Tasse  
Funktion ohne Batterien



### Einfachste Bedienung:



1. Teebeutel oder Tee-Ei einhängen und über der Tasse mit heißem Wasser positionieren.  
Timer bis zum Anschlag aufziehen, dabei senkt sich der Schnabel automatisch.

2. Gewünschte Zeit einstellen.

3. Der Schnabel hebt sich automatisch nach Ablauf der Zeit, ein Signal ertönt.

Viel Spaß beim Teegenuss!



## Scheiben-Zitronenpresse

lemon slice squeezer  
presse citron en tranche  
spremiagrumi  
prensa limones  
citronschijfjes pers

Höhe cm	inch	Art.-Nr.	EAN
9,0 x 7,0	3½ x 2¾	10 1518 28 00	4 007371 029605



GP = Produkt in farbigem Geschenkkarton



KE = auf Karte mit Euroloch

# Tee-Accessoires

Edelstahl rostfrei / stainless steel

	<b>Teefilter für Tassen</b>	Ø cm	Höhe cm	Ø inch	Art.-Nr.	EAN	
	tea strainer passe-thé passino tè colador de té theezeef	7,5	6,5	3	<b>10 4500 28 00</b>	4 007371 040754	

	<b>Teesiebe, 3-teilig</b>			Art.-Nr.	EAN	
	tea strainer, 3 pcs. passe-thé, 3 pcs. passino tè, 3 pz. colador de té, 3 pzs. theezeef, 3 stuks			<b>10 4501 28 00</b>	4 007371 037693	
Ø in den Größen: 50 mm, 65 mm, 75 mm 2 inch, 2,5 inch, 3 inch						

	<b>Tee-/Gewürzzange</b>	Ø cm		Ø inch	Art.-Nr.	EAN	
	tea/spice tongs pince à thé/épices pinza té/spezie pinzas té/especias thee/kruidentang	4,5		1½	<b>10 4502 28 04</b>	4 007371 025126	
		5,0		2	<b>10 4502 28 05</b>	4 007371 025133	
		6,5		2½	<b>10 4502 28 06</b>	4 007371 025140	

	<b>Tee-/Gewürzkugel</b>	Ø cm		Ø inch	Art.-Nr.	EAN	
	tea ball boule à thé/épices porta tè/spezie bola de té/especias thee/kruidentbol	5,0		2	<b>10 4503 28 05</b>	4 007371 029643	
		6,5		2½	<b>10 4503 28 06</b>	4 007371 029650	

	<b>Teesieb »Ceylon«</b>	Ø cm		Ø inch	Art.-Nr.	EAN	
	tea ball boule à thé porta tè bola de té theebol	6,0		2½	<b>10 4506 28 00</b>	4 007371 041423	



	<b>Teebeutel-Zange</b>	Länge cm		inch	Art.-Nr.	EAN	
	tea bag tongs pince à sachet de thé pinza per bustina di tè pinzas para bolso de té theezakjes tang	14,0		5½	<b>10 4509 28 00</b>	4 007371 043892	

	<b>Tee-Sieb »Ente«</b>	Ø cm	Höhe cm	Ø inch	Art.-Nr.	EAN	
	tea strainer passe-thé passino tè colador de té theezeef	5,0	8,0	2	<b>10 4511 00 00</b>	4 007371 055499	
		Kunststoff				<b>24 Stück im attraktiven Verkaufs-Display</b>	



# Tee-Accessoires

Edelstahl rostfrei / stainless steel



## Teebeutel-Klammer, 2 Stück im Set

tea bag clips  
clip pour filtre à thé  
clip per filtro di carta per tè  
bolsa de filtro de té  
thee filter houder

Länge	inch	Art.-Nr.	EAN
17,0	6½	10 4519 28 00	4 007371 060073

ideal für Tassen und Kannen



## Teebeutel-Halter, 2 Stück im Set

tea bag holder  
support de sachet de thé  
sostegno per bustine da tè  
soporto para la bolsa de té  
theezakjeshouder

Länge cm	inch	Art.-Nr.	EAN
16,0	6	10 4520 28 00	4 007371 059282

Design: Matthias Lehr



## Profi-Teesieb

tea strainer  
passe-thé  
passino tè  
colador de té  
theezeef

Ø cm	Höhe cm	Ø inch	Art.-Nr.	EAN
6,0	7,0	2½	10 4530 28 00	4 007371 042789



## Teesieb, schwimmend

tea strainer  
passe-thé  
passino tè  
colador de té  
theezeef

Ø cm	Höhe cm	Ø inch	Art.-Nr.	EAN
4,5	8,0	2	10 4531 28 00	4 007371 053815



mit Abtropfbehälter  
auch für Kräuter und Gewürze geeignet



## Teesieb »Leaf«, 4 Farben sortiert

tea strainer  
passe-thé  
passinoté  
colador de té  
theezheef

Ø cm	Höhe cm	Ø inch	Art.-Nr.	EAN
4,0	15,5	1½	10 4535 55 00	4 007371 060462



20 Stück im attraktiven Verkaufs-Display,  
Edelstahl/Silikon, farblich sortiert



## Stövchen »Ceylon«

tea warmer  
rechaud  
fornello  
calentador  
rechaud

Ø cm	Höhe cm	Ø inch	Art.-Nr.	EAN
14,0	4,5	5½	10 4600 28 15	4 007371 057462



inklusive Teelicht

reber  
VLBER  
DESIGN



## Tee-/Gewürzkugel

tea/spice ball  
boule à thé/épices  
porta tè/spezie  
bola de té/especies  
thee/kruidenbol

Ø cm	Ø inch	Art.-Nr.	EAN
6,3	2½	10 9990 28 06	4 007371 035309
10,5	4	10 9990 28 10	4 007371 035286



GP = Produkt in farbigem Geschenkkarton

KE = auf Karte mit Euroloch

# Teekannen

Edelstahl rostfrei / stainless steel

## Teekanne »Malawi«



tea pot, with filter  
théière, avec passoire  
teiera, con passino  
tetera, con colador  
theepot, met theezeef

Inhalt ltr.	Art.-Nr.	EAN	GP
0,8	10 4542 35 00	4 007371 057714	
1,0	10 4543 35 00	4 007371 057721	

Kanne aus Borosilikat-Glas mit Edelstahlfilter

## Teekanne »Earl Grey«



tea pot, with filter  
théière, avec passoire  
teiera, con passino  
tetera, con colador  
theepot, met theezeef

Inhalt ltr.	Art.-Nr.	EAN	GP
1,25	10 4560 28 00	4 007371 053136	

Kanne aus Borosilikat-Glas mit Edelstahlfilter

## Teegläser »Earl Grey« 2-teilig



tea glasses  
verres à thé  
bicchiere tè  
taza de te de vidrio  
theeglazen

Inhalt ltr.	Art.-Nr.	EAN	GP
0,2	10 4561 28 02	4 007371 054270	

Gläser aus Borosilikat-Glas

## Teekanne »Tibet«



tea pot, with filter  
théière, avec passoire  
teiera, con passino  
tetera, con colador  
theepot, met theezeef

Inhalt ltr.	Art.-Nr.	EAN	GP
0,4	10 4570 35 00	4 007371 054720	
0,8	10 4571 35 00	4 007371 054737	
1,2	10 4572 35 00	4 007371 054744	
1,5	10 4573 35 00	4 007371 057967	

Kanne aus Borosilikat-Glas mit Edelstahlfilter

## Teekanne »Lotus«



tea pot, with filter  
théière, avec passoire  
teiera, con passino  
tetera, con colador  
theepot, met theezeef

Inhalt ltr.	Art.-Nr.	EAN	GP
0,7	10 4580 28 00	4 007371 054751	
1,2	10 4581 28 00	4 007371 054768	

Kanne aus Borosilikat-Glas mit Edelstahlfilter

## Teekanne »Yasmin«



tea pot, with filter  
théière, avec passoire  
teiera, con passino  
tetera, con colador  
theepot, met theezeef

Inhalt ltr.	Art.-Nr.	EAN	GP
1,2	10 4590 10 00	4 007371 057202	

Kanne aus Gusseisen, innen emailliert mit Edelstahlfilter

# Teekannen



## Teekanne »Farmhouse«, schwarz

tea pot, with filter  
théière, avec passoire  
teiera, con passino  
tetera, con colador  
theepot, met theezeeef

Inhalt ltr.	Art.-Nr.	EAN	GP
0,6	10 4700 10 06	4 007371 060097	
1,2	10 4700 10 12	4 007371 060103	
1,6	10 4700 10 16	4 007371 060110	

Kanne aus Steinzeug mit Edelstahlfilter



## Teekanne »Farmhouse«, rot

tea pot, with filter  
théière, avec passoire  
teiera, con passino  
tetera, con colador  
theepot, met theezeeef

Inhalt ltr.	Art.-Nr.	EAN	GP
0,6	10 4700 14 06	4 007371 060127	
1,2	10 4700 14 12	4 007371 060134	
1,6	10 4700 14 16	4 007371 060141	

Kanne aus Steinzeug mit Edelstahlfilter



## Teekanne »Farmhouse«, weiß

tea pot, with filter  
théière, avec passoire  
teiera, con passino  
tetera, con colador  
theepot, met theezeeef

Inhalt ltr.	Art.-Nr.	EAN	GP
0,6	10 4700 22 06	4 007371 060158	
1,2	10 4700 22 12	4 007371 060165	
1,6	10 4700 22 16	4 007371 060172	

Kanne aus Steinzeug mit Edelstahlfilter



GP = Produkt in farbigem Geschenkkarton

KE = auf Karte mit Euroloch



# Kaffee-Accessoires / Nussknacker

Edelstahl rostfrei / stainless steel

## Nussknacker »Classic« verchromt

nut cracker  
casse-noix  
schiaccianoci  
cascanueces  
notenkraker



Länge cm	inch	Art.-Nr.	EAN
16,0	6½	08 0900 38 00	4 007371 043359

## Nussknacker »Soft touch«

nut cracker  
casse-noix  
schiaccianoci  
cascanueces  
notenkraker



Länge cm	inch	Art.-Nr.	EAN
18,5	7½	10 0527 30 00	4 007371 048361

aluminiumbeschichtet  
**12 Stück im attraktiven Verkaufs-Display**

## Türkisch Mocca / Aufschäumbecher

foam cup  
gobelet mousse  
caffetiera  
jarra leche  
turkse morkakan



Ø cm	Höhe cm	Inhalt ltr.	inch	Art.-Nr.	EAN
6,5	7,5	0,2	2½	10 1077 28 02	4 007371 025164
8,0	9,0	0,4	3½	10 1077 28 04	4 007371 025171
10,0	11,5	0,7	4½	10 1077 28 07	4 007371 025188

## Espressokocher »Napoli«

coffeemaker  
cafetière espresso  
caffettiera  
cafetera  
espressokoker



Inhalt	capacity	Art.-Nr.	EAN
3 Tassen	3 cups	18 1000 30 03	4 007371 045377
6 Tassen	6 cups	18 1000 30 06	4 007371 045384

Aluminium

## Milchaufschäumer »Latteforte«

Länge cm	Art.-Nr.	EAN
21,0	18 3000 10 00	4 007371 039871

inklusive 2AA Batterien



# Praktische Küchenhelfer

Gesunde Küche und schnelle Zubereitung ist kein Widerspruch mehr.  
Die praktischen Küchenhelfer lassen die Herzen von Profis und  
Genießern höher schlagen.



# Praktische Küchenhelfer

Edelstahl rostfrei / stainless steel

	<b>Eisportionierer</b>	Ø cm   Länge cm	Ø inch	Art.-Nr.	EAN		
	ice cream scoop cuillère à glace porzionatore gelato cuchara para helado ijs portioneerschep	5,0   22,0	8½	10 1950 28 00			
	<b>Dämpfeinsatz, klappbar</b>	Ø cm	Ø inch	Art.-Nr.	EAN		
	steaming insert, foldable élément vapeur rabattable cestello a vapore, ribaltabile soporte hervir, plegable stoominzet, inklapbaar	20,0	8	10 2548 28 20			
		24,0	9½	10 2548 28 24			
	<b>Setzei-Ring, Form: Kreis</b>	Ø cm	Ø inch	Art.-Nr.	EAN		
	ring for fried egg rond pour œuf sur le plat anello per uovo fritto anillo para huevo frito eierbak-ring	8,5	3½	10 2600 28 00			
		2 Ringe im Set					
	<b>Setzei-Ring, Form: Blume</b>	Ø cm	Ø inch	Art.-Nr.	EAN		
	ring for fried egg rond pour œuf sur le plat anello per uovo fritto anillo para huevo frito eierbak-ring	10,5	4	10 2610 28 00			
		2 Ringe im Set					
	<b>Setzei-Ring, Form: Herz</b>	Ø cm	Ø inch	Art.-Nr.	EAN		
	ring for fried egg rond pour œuf sur le plat anello per uovo fritto anillo para huevo frito eierbak-ring	9,5	4	10 2620 28 00			
		2 Ringe im Set					
	<b>Trocknerbälle »Dryerballs«, 2er Set</b>	Ø cm	Ø inch	Art.-Nr.	EAN		
	dryer balls balles de séchage sfere asciuga biancheria bolas para secadora drogerballen	6,5	2½	05 5000 00 02			
		Material: Kunststoff 12 Stück im attraktiven Verkaufs-Display					
	<b>Spülbürste »Swashies«</b>	Höhe cm	inch	Art.-Nr.	EAN		
	dish washing brush brosse pour vaisselle spazzolino cepillo cocina afwasborstel	21,0	8¼	05 7000 00 00			
		Material: Kunststoff 12 Stück im attraktiven Verkaufs-Display, farblich sortiert					
	<b>Spülbürste »Ente«</b>	Höhe cm	inch	Art.-Nr.	EAN		
	dish washing brush brosse pour vaisselle spazzolino cepillo cocina afwasborstel	9,5	3¾	05 7001 16 00			
		Material: Kunststoff 12 Stück im attraktiven Verkaufs-Display					



# Praktische Küchenhelfer

Edelstahl rostfrei / stainless steel

## Hummerzange

lobster tongs  
pince à homard  
pinza aragosta  
pinzas bogavante  
kreeftentang



Länge cm	inch	Art.-Nr.	EAN	GP
18,5	7½	10 3950 28 00	4 007371 043564	

## Hummergabeln, 4er Set

lobster forks  
fourchettes à homard  
forchetta aragosta  
tenedores bogavante  
kreeftenvorkje



Länge cm	inch	Art.-Nr.	EAN	GP
23,0	9	10 3951 28 04	4 007371 043588	



## Austernhandschuh

oyster glove  
gant à huîtres  
guanto in acciaio per ostriche  
guante protección  
oester handschoen



Länge cm	inch	Art.-Nr.	EAN	GP
24,0	9½	10 3970 28 00	4 007371 043564	

aus Kettenstahl gefertigt, sehr hochwertig verarbeitet

geeignet für Rechts- und Linkshänder



## Abtropfgestell mit Tablett, verchromt

dish draining rack  
égouttoir, avec plateau  
scolatoio  
escurridor platos  
afdruiprek met plateau



Art.-Nr.	EAN	GP
10 9035 38 00	4 007371 045674	

Tablett: 45,0 x 26,5 / 18 x 10½ inch  
Gestell: 42,5 x 34,0 / 17 x 13½ inch

GP = Produkt in farbigem Geschenkkarton

KE = auf Karte mit Euroloch



## Grillen

Alles für Ihr Grillvergnügen – trendige Grillkörbe oder innovative Hähnchengriller sowie praktische Grillkoffer lassen keine Wünsche offen.

BBQ-Fans werden begeistert sein.





# Grillen

Edelstahl rostfrei / stainless steel



KÜCHENPROFI

## Fischgrillzange

BBQ tongs for fish  
pince à grill pour poisson  
pinza barbeque per pesce  
pinzas barbacoa para pescado  
vis-grilltang

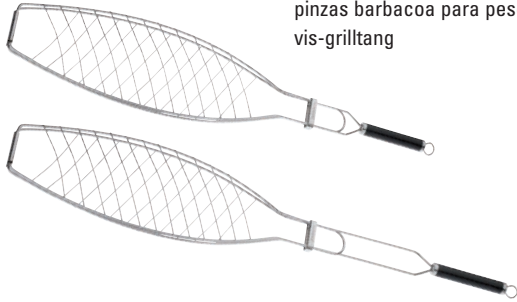

	Länge cm	inch	Art.-Nr.	EAN
kurzer Griff	56,0	22	10 6605 28 00	4 007371 054614
langer Griff	72,0	29	10 6600 28 00	4 007371 037082

Griff aus hochwertigem, hitzeisoliertem Kunststoff, hitzebeständig bis 150°C

## Fischgrillzange, für 3 Fische

BBQ tongs for fish  
pince à grille pour poisson  
pinza barbeque per pesce  
pinzas barbacoa para pescado  
vis-grilltang

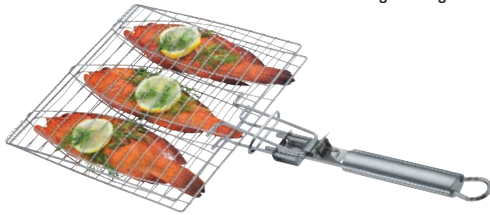

L/B/H cm	inch	Art.-Nr.	EAN	GP
63,0 x 28,0 x 28,0	25 x 11 x 11	10 6606 28 00	4 007371 059244	

mit abnehmbarem Griff  
auch für längliche Gemüsescheiben geeignet

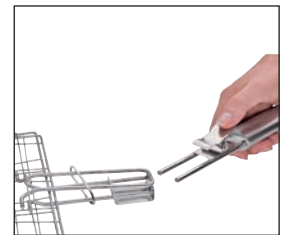

## Grill-Gemüsekorb »Flexi«

BBQ basket  
panier trouée pour légumes  
cestello forata per verdura  
cacerola para verdura  
groentenschal voor gril



L/B/H cm	inch	Art.-Nr.	EAN	GP
60,0 x 31,5 x 24,5	7½ x 4½ x 3	10 6607 28 00	4 007371 059251	

mit abnehmbarem Griff  
3-fach höhenverstellbar

ideal für Gemüse, Fisch oder Fleisch

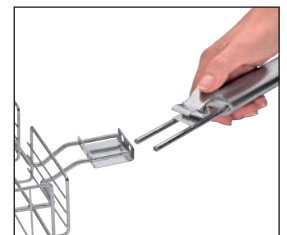



# Grillen

Edelstahl rostfrei / stainless steel



## Hähnchengriller »BBQ Advantage«

chicken roaster  
plat à rôti pour poulet  
cuocipollo  
asador e pollo  
kippengrill



Ø cm	Höhe cm	Ø inch	Art.-Nr.	EAN	GP
18,0	24,0	7	10 3801 28 00	4 007371 053433	

Fassungsvermögen Aromabehälter: 300 ml



## Hähnchen Grillkorb

chicken roaster  
plat à rôti pour poulet  
cuocipollo  
asador de pollo  
kippengrill



Ø cm	Höhe cm	Ø inch	Art.-Nr.	EAN	GP
20,0	10,0	8	10 6662 28 29	4 007371 056342	

Einsatz im Backofen oder auf dem Grill  
Fassungsvermögen Aromabehälter: 250ml



## BBQ-Gestell mit Tablett für Hühnerschenkel

chicken leg holder  
Grille de cuisson barbecue pour  
manchons de poulet  
Supporto BBQ per cosce  
di pollo con vassoio  
Soporte con bandeja  
para muslo de pollo  
BBQ kippengrill voor drumsticks



L/B/H cm	inch	Art.-Nr.	EAN	GP
38,0 x 15,5 x 14,5	15 x 6 x 5 7/8	10 6652 28 00	4 007371 060943	

zusammenklappbar  
Einsatz im Backofen oder auf dem Grill

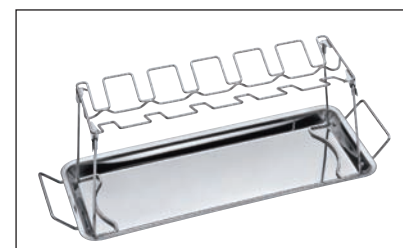

## Grill-Kartoffelhalter »Style«

potato rack  
support pour pomme de terre  
supporto di cottura per patate  
soporte para patatas  
aardappel houder



L/B/H cm	inch	Art.-Nr.	EAN	GP
43,0 x 9,0 x 5,0	17 x 3 1/2 x 2	10 6658 28 38	4 007371 059237	

gleichzeitiges Grillen von 4 Kartoffeln  
auch für Ofenkartoffeln geeignet

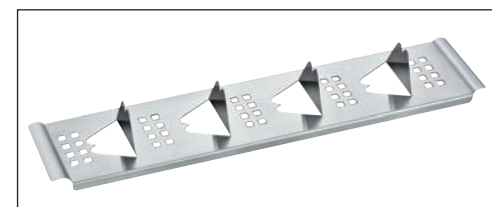

# Grillen

Edelstahl rostfrei / stainless steel



KÜCHENPROFI



## Marinaden-Set

marinade set  
set de marinade  
set per marinare  
set para marinar  
marinade set

	Höhe cm	Inhalt ltr.	inch	Art.-Nr.	EAN	
schw.	20,0	0,3	7¾	<b>09 8500 10 00</b>	4 007371 056809	
rot	20,0	0,3	7¾	<b>09 8500 14 00</b>	4 007371 056816	

**Set besteht aus:**  
Glas und Silikon-Pinsel



## Grillbretter »Smoky«, 2 Stück im Set

grill board  
planche à griller  
tabla de madera para barbacoa  
tavoleta di legno per grigliata  
grill plank

	L/B cm	inch	Art.-Nr.	EAN
S	30,0 x 15,0	11¾ x 6	<b>10 6655 10 02</b>	4 007371 053525
M	35,0 x 17,5	13¾ x 7	<b>10 6656 10 02</b>	4 007371 056373
L	40,0 x 15,0	15¾ x 6	<b>10 6657 10 02</b>	4 007371 054706

Zedernholz; mehrfach wiederverwendbar



## BBQ Grillkorb »Style«, hoch

BBQ basket  
panier pour légumes  
cestello per verdura  
cacerola para verdura  
groenteschaal voor grill

L/B/H cm	inch	Art.-Nr.	EAN	
25,5 x 21,0 x 7,5	10 x 8¼ x 3	<b>10 6659 28 21</b>	4 007371 059213	



## Grillpfanne / Grill-Gemüsekorb

BBQ basket  
panier trouée pour légumes  
cestello forata per verdura  
cacerola para verdura  
groenteschaal voor grill

Ø cm	Höhe cm	Ø inch	Art.-Nr.	EAN	
31,0	5,0	12	<b>10 6660 28 00</b>	4 007371 053709	
28,0	7,0	11	<b>10 6665 28 00</b>	4 007371 053716	



## Grillpfanne »Style«

BBQ pan  
planche pour grillades  
piastra per griglia  
bandeja para barbacoa  
grillplaat

L/B cm	inch	Art.-Nr.	EAN	
25,0 x 16,0	10 x 6	<b>10 6661 28 34</b>	4 007371 056328	
34,0 x 23,0	13½ x 9	<b>10 6661 28 43</b>	4 007371 056335	

ideal zum Grillen aller kleineren, empfindlichen Lebensmitteln wie Gemüse, Fisch oder Fleisch

# Grillen

Edelstahl rostfrei / stainless steel

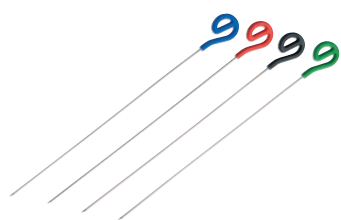

## Grillspieße, 4 Stück im Set

BBQ skewers  
broche pour grillade  
spiedi per la griglia  
pinchos barbacoa  
grillspies

Länge cm	inch	Art.-Nr.	EAN
30,5	12	10 6260 28 04	4 007371 052092

Griffe aus Silikon, hitzebeständig bis 250°C

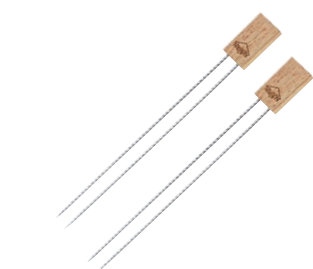

## Doppel-Grillspieße, 2 Stück im Set

double BBQ skewers  
double broche pour grillade  
spiedi doppio per la griglia  
pinchos doble barbacoa  
dubbel grillspies

Länge cm	inch	Art.-Nr.	EAN
36,0	14	10 6640 28 00	4 007371 054492



## BBQ Grillspieße, 2 Stück im Set

BBQ skewers  
broche pour grillade  
spiedi per la griglia  
pinchos barbacoa  
grillspies

Länge cm	inch	Art.-Nr.	EAN
47,0	18½	10 6641 28 02	4 007371 056069

Griff aus hochwertigem, hitzeisoliertem Kunststoff  
hitzebeständig bis 165°C



## Grillspieße »Flexi«, 2 Stück im Set

flexible BBQ skewers  
broche flexible pour grillade  
spiedi flexible per la griglia  
pinchas flexible barbacoa  
flexibel grillspies

Länge cm	inch	Art.-Nr.	EAN
77,0	30¾	10 6645 28 00	4 007371 054584



## Maiskolbenhalter, 4 Stück im Set

corn holder  
pique-épis de maïs  
spiedini per pannocchie  
pinchos para mazorcas  
maiskolf houder

Länge cm	inch	Art.-Nr.	EAN
7,5	3	10 6664 28 04	4 007371 058872



GP = Produkt in farbigem Geschenkkarton



KE = auf Karte mit Euroloch



# Grillen

Edelstahl rostfrei / stainless steel



## Grill-/Ofenhandschuh lang, 2 Stück im Set

oven gloves  
gants de four  
guanti da forno  
guantes para horno  
ovenhandschoenen

Länge cm	inch	Art.-Nr.	EAN	
39,0	15½	10 6000 10 39	4 007371 060431	

waschbar bei 40°C, geschmeidig, hitzebeständig und schwer entflammbar, mit Baumwolle gefüttert. 350°C Hitzeschutz



## Brat-/Grillzange, schwarz

all-purpose tongs  
pince universelle  
pinza per rivoltare  
pinzas de barbacoa  
grilltang

Länge cm	inch	Art.-Nr.	EAN	
27,0	10½	10 6635 10 27	4 007371 056212	
40,0	15¾	10 6635 10 40	4 007371 056229	

Funktionsteil aus Nylon; hitzebeständig bis 180°C



## Brat-/Wende-Pinzette

cooking tweezers  
pincette à tourner  
pinza per rivoltare  
pinzas freír  
kookpincet

Länge cm	inch	Art.-Nr.	EAN	
30,5	12	10 6800 28 00	4 007371 038317	



## Allzweckzange

all-purpose tongs  
pince universelle  
pinza universale  
pincas universal  
universeeltang

Länge cm	inch	Art.-Nr.	EAN	
30,0	12	10 6900 28 00	4 007371 038751	



## Silikon-Multizange

all-purpose tongs  
pince universelle  
pinza per rivoltare  
pinzas de cocina  
grilltang



Länge cm	inch	Art.-Nr.	EAN	
23,0	9	10 6980 28 23	4 007371 044196	
30,0	12	10 6980 28 30	4 007371 044202	

Funktionsteil mit Silikonbeschichtung; temperaturbeständig bis 220°C

# Grillen

Edelstahl rostfrei / stainless steel





	Ø cm	Ø inch	Art.-Nr.	EAN	
<b>Hamburgerpresse, 2-teilig</b>	12,0	4¾	<b>10 6666 30 12</b>	4 007371 054713	

hamburger press  
presse à hamburger  
stampa per hamburger  
prensa hamburguesa  
hamburgerpers



Aluminiumguss, beschichtet



	Ø / L cm	inch	Art.-Nr.	EAN	
<b>Hamburger-Grillzange, für 4 Hamburger</b>	11,5 x 55,0	4½ x 18	<b>10 6669 28 00</b>	4 007371 059138	

hamburger grilling basket  
pince à grillade pour hamburger  
griglia per hamburger  
pinzas barbacoa para hamburguesas  
hamburgergrilltang





	L/B/H cm	inch	Art.-Nr.	EAN	
<b>Fleischbeschwerer</b>	15,0 x 10,0 x 4,0	6 x 4 x ½	<b>10 6670 28 00</b>	4 007371 059145	

meat press  
presse à grillade  
peso per la cottura  
prensador para carne  
vleespers

schwere Qualität



	Ø cm	Ø inch	Art.-Nr.	EAN	
<b>Fleischbeschwerer, Gusseisen / Holz</b>	18,0	7	<b>10 6671 10 00</b>	4 007371 060486	

meat press  
presse à grillade  
peso per la cottura  
prensador para carne  
vleespers

schwere Qualität: 1kg



	Länge cm	inch	Art.-Nr.	EAN
<b>Hamburger-Wender extra groß</b>	45,0	17¾	<b>10 6672 28 00</b>	4 007371 060981

hamburger turner  
pelle à hamburger  
pala per hamburger  
espatula para hamburguesas  
hamburger turner



# Grillen

Edelstahl rostfrei / stainless steel



## Grillbürste

barbecue brush  
brosse à grille  
spazzola barbeque  
cepillo barbacoa  
grillborstel

Länge cm	inch	Art.-Nr.	EAN	GP
33,0	13	10 6932 28 33	4 007371 061063	
42,0	16½	10 6932 28 42	4 007371 061070	



## BBQ-Set »Virginia«, 3-teilig, schwarz

Art.-Nr.	EAN	GP
10 6959 10 03	4 007371 056298	

Edelstahl / Kunststoff

**Set besteht aus:**

Gabel: 39 cm; Grillzange: 40 cm; Wender: 42 cm



## BBQ-Set »Virginia«, 3-teilig, rot

Art.-Nr.	EAN	GP
10 6959 14 03	4 007371 056304	

Edelstahl / Kunststoff

**Set besteht aus:**

Gabel: 39 cm; Grillzange: 40 cm; Wender: 42 cm



## BBQ-Set »Arizona«, 16-teilig, Edelstahl

Art.-Nr.	EAN
10 6968 28 16	4 007371 059220

**Der Koffer aus schwarzem Aluminium enthält:** 1 Gabel 42 cm, 1 Wender 43 cm, 1 Zange 40 cm, 1 Grillbürste 43 cm, 6 Spieße 41 cm, 6 Maiskolbenhalter



## BBQ-Set »Phoenix«, 8-teilig, Edelstahl

Art.-Nr.	EAN
10 6968 28 08	4 007371 061056

**Der Koffer aus schwarzem Aluminium enthält:** 1 x Gabel 42 cm, 1 Wender 43 cm, 1 Zange 40 cm, 1 Grillbürste 43 cm, 4 Spieße 41 cm







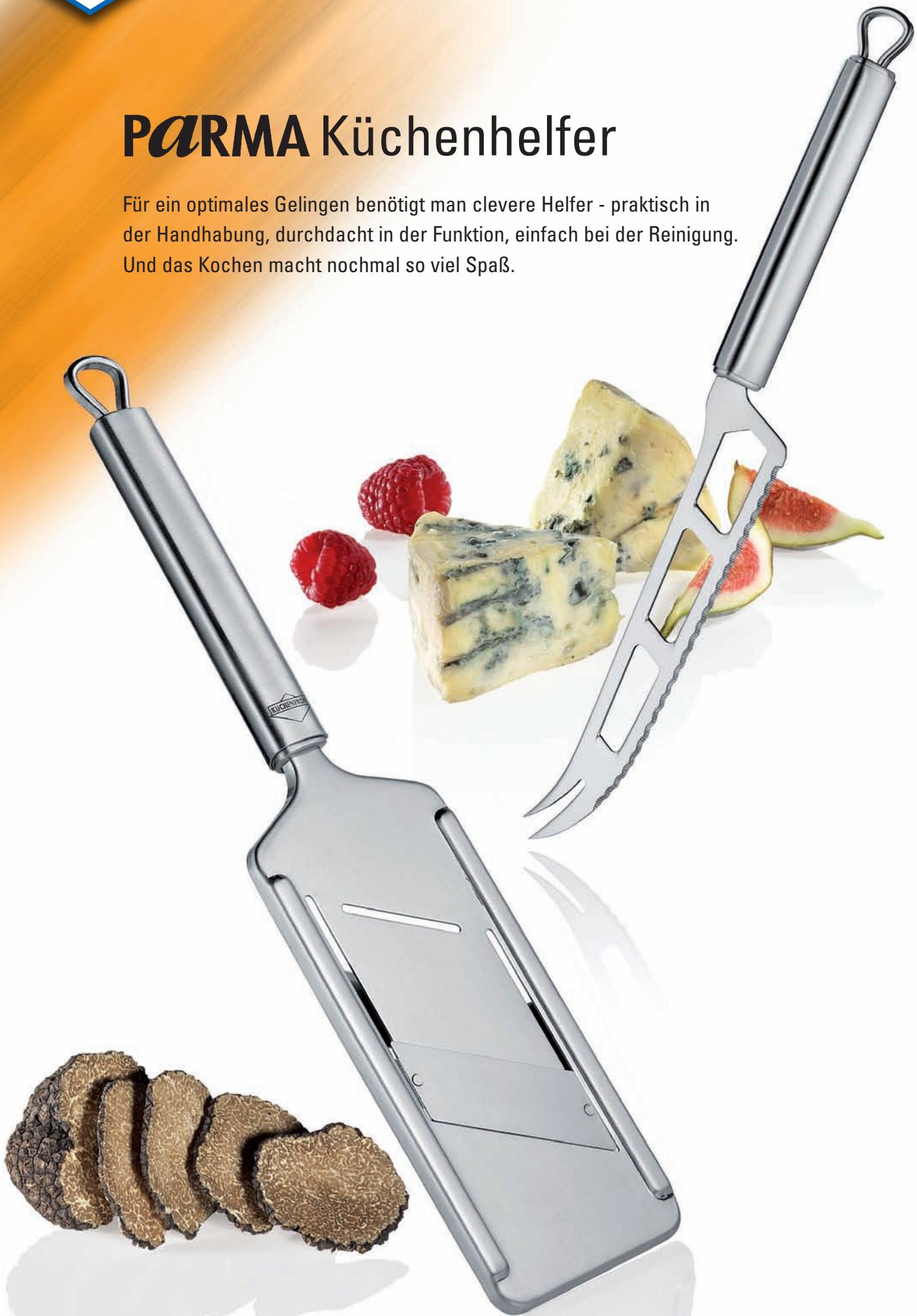











# PARMA Küchenhelfer

Für ein optimales Gelingen benötigt man clevere Helfer - praktisch in der Handhabung, durchdacht in der Funktion, einfach bei der Reinigung. Und das Kochen macht nochmal so viel Spaß.





- spülmaschinenfest
- Design: Ralph Krämer

	<p><b>Melonenausstecher</b></p> <p>melon baller boueur à melon scavino chucara vaciadora melonenballer</p>	<p>Gesamtlänge cm</p> <p>19,0</p>	<p>inch</p> <p>7½</p>	<p>Art.-Nr.</p> <p>12 1000 28 00</p>	<p>EAN</p>  <p>4 007371 030526</p>
	<p><b>Pizzaschneider</b></p> <p>pizza cutter roulette à pizza rotella tagliapizza cortador pizzas pizza snijder</p>	<p>Gesamtlänge cm</p> <p>21,0</p>	<p>inch</p> <p>8</p>	<p>Art.-Nr.</p> <p>12 1001 28 00</p>	<p>EAN</p>  <p>4 007371 030533</p>
	<p><b>Teigrädchen</b></p> <p>pastry cutter roulette à pâte rotella tagliapasta rueda cortamasa deegrader</p>	<p>Gesamtlänge cm</p> <p>19,5</p>	<p>inch</p> <p>7½</p>	<p>Art.-Nr.</p> <p>12 1003 28 00</p>	<p>EAN</p>  <p>4 007371 030552</p>
	<p><b>Austernbrecher</b></p> <p>oyster knife couteau à huitres coltello ostriche rompeostras oestermes</p>	<p>Gesamtlänge cm</p> <p>21,0</p>	<p>inch</p> <p>8</p>	<p>Art.-Nr.</p> <p>12 1004 28 00</p>	<p>EAN</p>  <p>4 007371 030564</p>
	<p><b>Käsemesser</b></p> <p>cheese knife couteau à fromage coltello formaggio cuchillo queso kaasmes</p>	<p>Gesamtlänge cm</p> <p>30,0</p>	<p>inch</p> <p>12</p>	<p>Art.-Nr.</p> <p>12 1007 28 00</p>	<p>EAN</p>  <p>4 007371 030595</p>
	<p><b>Palettenmesser</b></p> <p>palette knife couteau pelle paletta tagliapizza pala-cuchillo paletmes</p>	<p>Gesamtlänge cm</p> <p>29,5</p>	<p>inch</p> <p>11½</p>	<p>Art.-Nr.</p> <p>12 1008 28 00</p>	<p>EAN</p>  <p>4 007371 030600</p>
	<p><b>Zitronenzester</b></p> <p>lemon zester zesteur rigalimoni rallador limón citroenschiltrekker</p>	<p>Gesamtlänge cm</p> <p>18,0</p>	<p>inch</p> <p>7</p>	<p>Art.-Nr.</p> <p>12 1009 28 00</p>	<p>EAN</p>  <p>4 007371 030618</p>
	<p><b>Muskat- und Zitronenreibe</b></p> <p>nutmeg grater râpe à muscade grattugia noce moscata rallador nuez moscada nootmuskaatrasp</p>	<p>Gesamtlänge cm</p> <p>26,5</p>	<p>inch</p> <p>10½</p>	<p>Art.-Nr.</p> <p>12 1010 28 00</p>	<p>EAN</p>  <p>4 007371 030625</p>





■ spülmaschinenfest  
■ Design: Ralph Krämer

	<p><b>Käsehobel</b> cheese plane rabot à fromage taglia formaggio cortador queso kaasschaaf</p>	<table border="1"> <thead> <tr> <th>Gesamtlänge cm</th> <th>inch</th> <th>Art.-Nr.</th> <th>EAN</th> </tr> </thead> <tbody> <tr> <td>26,0</td> <td>10</td> <td>12 1011 28 00</td> <td>4 007371 030632</td> </tr> </tbody> </table>	Gesamtlänge cm	inch	Art.-Nr.	EAN	26,0	10	12 1011 28 00	4 007371 030632
Gesamtlänge cm	inch	Art.-Nr.	EAN							
26,0	10	12 1011 28 00	4 007371 030632							
	<p><b>Apfelausstecher</b> apple corer épineur foramele descorazonador manzana appelboor</p>	<table border="1"> <thead> <tr> <th>Gesamtlänge cm</th> <th>inch</th> <th>Art.-Nr.</th> <th>EAN</th> </tr> </thead> <tbody> <tr> <td>24,0</td> <td>9½</td> <td>12 1012 28 00</td> <td>4 007371 030649</td> </tr> </tbody> </table>	Gesamtlänge cm	inch	Art.-Nr.	EAN	24,0	9½	12 1012 28 00	4 007371 030649
Gesamtlänge cm	inch	Art.-Nr.	EAN							
24,0	9½	12 1012 28 00	4 007371 030649							
	<p><b>Palette, gelocht</b> palette with holes pelle à trous paletta forata pala perforada bakspaan</p>	<table border="1"> <thead> <tr> <th>Gesamtlänge cm</th> <th>inch</th> <th>Art.-Nr.</th> <th>EAN</th> </tr> </thead> <tbody> <tr> <td>28,5</td> <td>11</td> <td>12 1013 28 00</td> <td>4 007371 030656</td> </tr> </tbody> </table>	Gesamtlänge cm	inch	Art.-Nr.	EAN	28,5	11	12 1013 28 00	4 007371 030656
Gesamtlänge cm	inch	Art.-Nr.	EAN							
28,5	11	12 1013 28 00	4 007371 030656							
	<p><b>Sparschäler, quer</b> movable peeler éplucheur pela verdura pela verduras dunschiller</p>	<table border="1"> <thead> <tr> <th>Gesamtlänge cm</th> <th>inch</th> <th>Art.-Nr.</th> <th>EAN</th> </tr> </thead> <tbody> <tr> <td>19,0</td> <td>7½</td> <td>12 1014 28 00</td> <td>4 007371 030663</td> </tr> </tbody> </table>	Gesamtlänge cm	inch	Art.-Nr.	EAN	19,0	7½	12 1014 28 00	4 007371 030663
Gesamtlänge cm	inch	Art.-Nr.	EAN							
19,0	7½	12 1014 28 00	4 007371 030663							
	<p><b>Sparschäler, hochkant</b> movable peeler éplucheur pela verdura pela verduras dunschiller</p>	<table border="1"> <thead> <tr> <th>Gesamtlänge cm</th> <th>inch</th> <th>Art.-Nr.</th> <th>EAN</th> </tr> </thead> <tbody> <tr> <td>22,0</td> <td>8½</td> <td>12 1015 28 00</td> <td>4 007371 030670</td> </tr> </tbody> </table>	Gesamtlänge cm	inch	Art.-Nr.	EAN	22,0	8½	12 1015 28 00	4 007371 030670
Gesamtlänge cm	inch	Art.-Nr.	EAN							
22,0	8½	12 1015 28 00	4 007371 030670							
	<p><b>Dosenöffner</b> can opener ouvre boîte apriscatole abrelatas blikopener</p>	<table border="1"> <thead> <tr> <th>Gesamtlänge cm</th> <th>inch</th> <th>Art.-Nr.</th> <th>EAN</th> </tr> </thead> <tbody> <tr> <td>22,0</td> <td>8½</td> <td>12 1017 28 00</td> <td>4 007371 030960</td> </tr> </tbody> </table>	Gesamtlänge cm	inch	Art.-Nr.	EAN	22,0	8½	12 1017 28 00	4 007371 030960
Gesamtlänge cm	inch	Art.-Nr.	EAN							
22,0	8½	12 1017 28 00	4 007371 030960							
	<p><b>Dessertportionierer</b> dessert server portionneur à dessert porzioniere per gelato porcionador helado dessert-dienlepel</p>	<table border="1"> <thead> <tr> <th>Gesamtlänge cm</th> <th>inch</th> <th>Art.-Nr.</th> <th>EAN</th> </tr> </thead> <tbody> <tr> <td>22,5</td> <td>9</td> <td>12 1022 28 00</td> <td>4 007371 032582</td> </tr> </tbody> </table>	Gesamtlänge cm	inch	Art.-Nr.	EAN	22,5	9	12 1022 28 00	4 007371 032582
Gesamtlänge cm	inch	Art.-Nr.	EAN							
22,5	9	12 1022 28 00	4 007371 032582							
	<p><b>Nylonwender</b> nylon turner pelle nylon paletta nylon pala freir nylon nylonspaan</p>	<table border="1"> <thead> <tr> <th>Gesamtlänge cm</th> <th>inch</th> <th>Art.-Nr.</th> <th>EAN</th> </tr> </thead> <tbody> <tr> <td>35,5</td> <td>14</td> <td>12 1027 28 00</td> <td>4 007371 033619</td> </tr> </tbody> </table>	Gesamtlänge cm	inch	Art.-Nr.	EAN	35,5	14	12 1027 28 00	4 007371 033619
Gesamtlänge cm	inch	Art.-Nr.	EAN							
35,5	14	12 1027 28 00	4 007371 033619							

Funktionsteil hitzebeständig bis 210°C



GP = Produkt in farbigem Geschenkkarton



KE = auf Karte mit Euroloch





- spülmaschinenfest
- Design: Ralph Krämer

	<b>Gourmethobel</b>	Gesamtlänge cm	inch	Art.-Nr.	EAN
truffle plane râpe à truffe tagliatartufi cortador universale truffelrasp	30,0	12	<b>12 1029 28 00</b>		
	<b>Schöpflöffel</b>	Gesamtlänge cm	inch	Art.-Nr.	EAN
soup ladle louche mestolo cazo sopa soeplepel	32,0	12½	<b>12 1500 28 00</b>		
	<b>Saucenlöffel</b>	Gesamtlänge cm	inch	Art.-Nr.	EAN
sauce ladle cuillère à sauce cucchiaio salse cazo salsas sauslepel	30,0	12	<b>12 1501 28 00</b>		
	<b>Kartoffelstampfer</b>	Gesamtlänge cm	inch	Art.-Nr.	EAN
potato masher presse purée schiacciapatate prensa patatas aardappelstamper	30,5	12	<b>12 1502 28 00</b>		
	<b>Schaumlöffel</b>	Gesamtlänge cm	inch	Art.-Nr.	EAN
skimmer écumoire schiumarola espumadera schuimspaan	36,0	14	<b>12 1503 28 00</b>		
	<b>Fleischgabel</b>	Gesamtlänge cm	inch	Art.-Nr.	EAN
meat fork fourchette à viande forchettone tenedor carne vleesfork	35,0	13½	<b>12 1504 28 00</b>		
	<b>Servierlöffel</b>	Gesamtlänge cm	inch	Art.-Nr.	EAN
serving spoon cuillère à servir cucchiaione cucharón servir serveerlepel	33,5	13	<b>12 1505 28 00</b>		
	<b>Wender</b>	Gesamtlänge cm	inch	Art.-Nr.	EAN
turner pelle pala pala freir bakspaan	34,5	13½	<b>12 1506 28 00</b>		







■ spülmaschinenfest  
■ Design: Ralph Krämer

	<b>Spaghettiheber</b>	Gesamtlänge cm	inch	Art.-Nr.	EAN
	spaghetti server cuillère à spaghetti mestolo spaghetti cucharón spaghetti spaghettilepel	32,5	12½	<b>12 1507 28 00</b>	4 007371 031929

	<b>Schneebeesen</b>	Gesamtlänge cm	inch	Art.-Nr.	EAN
	standard whisk fouet frusta batidor garde	30,0	12	<b>12 1508 28 00</b>	4 007371 032094

	<b>Eierwender, Nylon</b>	Gesamtlänge cm	inch	Art.-Nr.	EAN
	egg lifter pelle à œufs paletta pala freir eierbakspaan	38,0	15	<b>12 1509 28 00</b>	4 007371 035330

Funktionsteil hitzebeständig bis 210°C

	<b>Käseschneider</b>	Gesamtlänge cm	inch	Art.-Nr.	EAN
	cheese cutter coupe-fromage taglia formaggio cuchillo para queso kaassnijder	29,0	11½	<b>12 1515 28 00</b>	4 007371 037617



mit Draht für 2 Schnittstärken, mit Servierspitze

	<b>S-Haken, 6er Set</b>	Gesamtlänge cm	inch	Art.-Nr.	EAN
	S-hook chromeplated 6 pcs. set crochet-S chromé 6 pièces uncino-S cromato 6 pz. ganchos-S cromados 6 pzas. S-haken chrom, set van 6 stuks	5,0	2	<b>10 5100 38 06</b>	4 007371 025638

verchromt

	<b>S-Haken</b>	Gesamtlänge cm	inch	Art.-Nr.	EAN
	S-hook chromeplated crochet-S chromé uncino-S cromato ganchos-S cromados S-haak chrom	5,0	2	<b>10 5100 38 50</b>	4 007371 011426
		6,5	2½	<b>10 5100 38 65</b>	4 007371 018968

verchromt

	<b>Wandkitchenleiste, mit Haken</b>	Gesamtlänge cm	inch	Art.-Nr.	EAN	
	heavy grade utensil rack with hooks barre murale avec crochets appendimestolo con uncini listón de pared con ganchos keukenstang met haken	50,0	19	<b>10 5500 28 05</b>	4 007371 008068	
		60,0	23½	<b>10 5500 28 06</b>	4 007371 008105	

inklusive Dübel und Schrauben

# Küchenhelfer

Edelstahl rostfrei / stainless steel



## Schneebeesen

standard whisk  
fouet  
frusta  
batidor  
garde

Länge cm	inch	Art.-Nr.	EAN
15,0	6	10 3504 28 15	4 007371 030397
20,0	8	10 3504 28 20	4 007371 016865
25,0	10	10 3504 28 25	4 007371 016247
30,0	12	10 3504 28 30	4 007371 016254



## Kartoffelstampfer »Promo«

potato masher  
presse purée  
schiacciapatate  
prensa patatas  
aardappelstampfer

Länge cm	inch	Art.-Nr.	EAN
30,0	12	11 0549 28 00	4 007371 020640

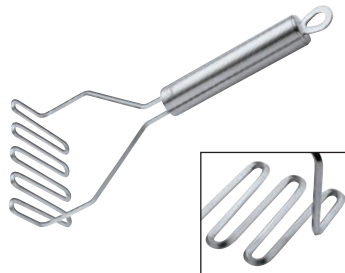

## Kartoffelstampfer »Profi«

potato masher  
presse purée  
schiacciapatate  
prensa patatas  
aardappelstampfer

Länge cm	inch	Art.-Nr.	EAN
29,0	11½	11 0600 28 00	4 007371 044073

speziell geformter, eckiger Draht  
extra dicker Griff

**Magnetleiste**  
magnetic knife rack  
barre magnétique pour couteaux  
barra magnetica per coltelli  
listón magnético para cuchillos  
magnetische messenhouder

L/H cm	inch	Art.-Nr.	EAN
35,5 x 6,0	14 x 2½	10 9100 28 00	4 007371 036269

inklusive Schrauben und Dübel



## Spülbürste »Classic«, mit Naturborsten

dish washing brush  
brosse pour vaisselle  
spazzolino  
cepillo cocina  
afwasborstel

Gesamtlänge cm	inch	Art.-Nr.	EAN
25,0	10	11 0943 28 00	4 007371 033466

Bürstenkopf austauschbar

Design: Ralph Krämer



<b>Ersatzbürste 2er Set</b>	11 0943 00 02	4 007371 033473
-----------------------------	---------------	-----------------











# Siebe

Edelstahl rostfrei / stainless steel



## Profi-Qualität

- extra feines und stabiles Gewebe
- Gewebe mit Rand verschweißt
- Spezial-Verschweißung der Griffe
- große Auflage

	<b>Teesieb</b> tea strainer passe-thé passino tè colador té theezeef	Ø cm 7,5	Ø inch 3	Art.-Nr. 11 0990 28 07	EAN 4 007371 000314
	<b>Küchensieb</b> strainer passoire setaccio colador cocina keukenzeef	Ø cm 9,0	Ø inch 3½	Art.-Nr. 11 0990 28 09	EAN 4 007371 002387
	setaccio colador cocina keukenzeef	12,0	5	11 0990 28 12	4 007371 000321
	keukenzeef	16,0	6½	11 0990 28 16	4 007371 017275
	<b>Küchensieb</b> strainer passoire setaccio colador cocina keukenzeef	Ø cm 18,0	Ø inch 7	Art.-Nr. 11 0990 28 18	EAN 4 007371 000345
	setaccio colador cocina keukenzeef	20,0	8	11 0990 28 20	4 007371 017282
	keukenzeef	22,0	8½	11 0990 28 22	4 007371 025058
	<b>Spitzsieb</b> conical sieve chinois conique colino conico colador cónica puntzeef	Ø cm 18,0	Ø inch 7	Art.-Nr. 11 0993 28 18	EAN 4 007371 055505
professionelle Qualität feines, stabiles Gewebe					

# Salatschleudern und mehr

Unerlässliche Helfer für die Verarbeitung frischer Zutaten -  
Salatschleudern und Dressingshaker, Spätzlepressen und  
Käsereiben, Multischneider und Kräutermühlen.

Die Kreativität kommt von Ihnen, die Accessoires von uns.



# Praktische Küchenhelfer

Edelstahl rostfrei / stainless steel

## Knoblauchschneider

garlic plane  
rabot-ail  
taglia aglio  
corta-ajos  
knoflookschaaf



L/B cm	inch	Art.-Nr.	EAN
21,0 x 5,0	8¼ x 2	13 1005 28 00	8 001603 020602

## Knoblauchschäler

garlic peeler  
éplucher d'ail  
sbuccia aglio  
pelador de ajo  
knoflookschiller



Länge cm	inch	Art.-Nr.	EAN
13,0	5	13 1600 12 00	4 007371 041256

24 Stück im attraktiven Verkaufs-Display

## Knoblauchpresse »Quick«, beschichtet

garlic press  
éplucheur d'ail  
spremiaglio  
prensa ajos  
knoflookpers



Länge cm	inch	Art.-Nr.	EAN
20,0	8	13 7010 30 00	4 007371 035651

Aluminium, beschichtet, zum Pressen von ungeschälten Knoblauchzehen geeignet

24 Stück im attraktiven Verkaufs-Display



## Knoblauchpresse/ -schneider

garlic press/cutter  
presse/coupe ail  
spremi/taglia aglio  
prensa/cortador ajos  
knoflookpers/snijder



Länge cm	inch	Art.-Nr.	EAN
19,5	7¾	13 7012 70 00	4 007371 054386

zum Pressen und Schneiden

## Kompaktseife »deluxe«

stainless steel soap  
savon en inox  
sapone inox  
jabón inox  
edelstaal keukenzeep



Ø cm	Ø inch	Art.-Nr.	EAN
8,0	3	13 1025 28 00	4 007371 034067

24 Stück im attraktiven Verkaufs-Display



# Kartoffel- /Spätzlepressen, Pommes-Frites-Schneider

Edelstahl rostfrei / stainless steel



## Kartoffelpresse

potato press  
presse purée  
schiacciapatate  
prensa-patatas  
pureepers

Ø cm	Länge cm	Ø inch	Art.-Nr.	EAN	GP
8,0	27,0	10½	13 1008 28 00	4 007371 030762	



## Kartoffel-/Spätzlepresse

potato / spaetzle press  
presse purée / spaetzle  
schiacciapatate / -gnocchetti  
prensa patatas /pasta fresca  
puree- /spätzlepers

Ø cm	Länge cm	Ø inch	Art.-Nr.	EAN	GP
8,0	37,0	3	13 1056 28 00	4 007371 041409	



## Kartoffelpresse »Comfort«

potato press  
presse purée  
schiacciapatate  
prensa-patatas  
pureepers

L/B cm	inch	Art.-Nr.	EAN	GP
31,5 x 12,5	12½ x 5	13 1069 28 00	4 007371 045919	



## Kartoffel-/Spätzlepresse »Spätzleboy«

potato / spaetzle press  
presse purée / spaetzle  
schiacciapatate / -gnocchetti  
prensa patatas /pasta fresca  
puree- /spätzlepers

Ø cm	Länge cm	Ø inch	Art.-Nr.	EAN	GP
9,0	42,0	3½	13 1075 30 00	4 007371 056359	

Aluminium-Guss  
auch für Spaghetti-Eis geeignet



## Pommes-Frites-Schneider

potato cutter  
coupe pomme de terre  
taglia-patatine  
cortador patatas  
patat snijder

L/B/H cm	inch	Art.-Nr.	EAN	GP
26,0 x 9,0 x 12,5	10 x 3½ x 5	13 1057 28 00	4 007371 041867	

mit 2 Schneide-Einsätzen (32er und 64er)

# Schneiden / Zerkleinern

hochwertige Kunststoffe / high quality plastics

Praktische Küchenhelfer



## Multischneider, patentierte Antriebstechnik

multi chopper  
multi hachoir  
tritattutto  
tritadora  
multi verkleiner



Ø cm	Höhe cm	Inhalt ltr.	Ø inch	Art.-Nr.	EAN	
13,5	12,0	0,75	5½	13 0750 22 00	4 100737 1060479	

Antriebsdeckel, Schleudereinsatz, Schneideinsatz, Aufweiser und Schutzhülle, Mixeinsatz, 0,75L Behälter mit Mikrowellendeckel

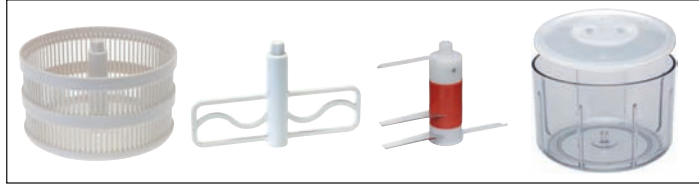

## Tomatenschneider

tomato slicer  
trancheur à tomate  
tagliapomodori  
cortador de tomates  
tomatensnijder



L/B cm	inch	Art.-Nr.	EAN	
21,5 x 11	8½	13 0709 22 00	4 100737 1060639	

extra scharfe, gezahnte Klingen  
auch geeignet für Champignons oder Mozzarella

## Petersilien-/Kräutermühle

parsley / herbs mill  
moulin à fines herbes  
macinino per erbe  
molinillo de hierbas  
peterseliemolen



Ø / H cm	Ø inch	Art.-Nr.	EAN	
7,0 / 13,0	3	13 0711 22 00	4 100737 1060882	



## Ananasschneider

pineapple slicer  
découpe ananas  
taglia ananas  
cortador de piña  
ananassnijder



Länge cm	inch	Art.-Nr.	EAN	
24,0	9½	13 1091 28 00	4 100737 1059152	

Edelstahl rostfrei

# Salatschleudern

hochwertige Kunststoffe / high quality plastics

bestehend aus:  
Abtropfsieb, Schüssel und  
Deckel mit Seilzugtechnik



KÜCHENPROFI



## Salatschleuder, schwarz

salad spinner  
essoreuse à salade  
centrifuga per insalata  
centrifugadora de ensalada  
slacentrifuge

Ø cm	Höhe cm	Inhalt ltr.	Ø inch	Art.-Nr.	EAN
24,0	16,0	3,25	9½	13 1017 10 00	4 007371 047197

für perfektes Trocknen

Design: Ralph Krämer



## Salatschleuder, grün

salad spinner  
essoreuse à salade  
centrifuga per insalata  
centrifugadora de ensalada  
slacentrifuge

Ø cm	Höhe cm	Inhalt ltr.	Ø inch	Art.-Nr.	EAN
24,0	16,0	3,25	9½	13 1017 11 00	4 007371 055932

für perfektes Trocknen

Design: Ralph Krämer



## Salatschleuder, rot

salad spinner  
essoreuse à salade  
centrifuga per insalata  
centrifugadora de ensalada  
slacentrifuge

Ø cm	Höhe cm	Inhalt ltr.	Ø inch	Art.-Nr.	EAN
24,0	16,0	3,25	9½	13 1017 14 00	4 007371 047203

für perfektes Trocknen

Design: Ralph Krämer



## Salatschleuder, weiß

salad spinner  
essoreuse à salade  
centrifuga per insalata  
centrifugadora de ensalada  
slacentrifuge

Ø cm	Höhe cm	Inhalt ltr.	Ø inch	Art.-Nr.	EAN
24,0	16,0	3,25	9½	13 1017 22 00	4 007371 030458

für perfektes Trocknen

Design: Ralph Krämer



## Salatschleuder »Mini«, weiß

salad spinner  
essoreuse à salade  
centrifuga per insalata  
centrifugadora de ensalada  
slacentrifuge

Ø cm	Höhe cm	Inhalt ltr.	Ø inch	Art.-Nr.	EAN
20,0	19,5	2,5	8	13 1018 22 00	4 007371 057837

Kurbelfunktion

praktische Öffnung zum Einfüllen oder Abgießen



GP = Produkt in farbigem Geschenkkarton



KE = auf Karte mit Euroloch



# Salatschleudern / Küchenhelfer

hochwertige Kunststoffe, Edelstahl / high quality plastics, stainless steel



## Salatschleuder »Maxi«, weiß

salad spinner  
essoreuse à salade  
centrifuga per insalata  
centrifugadora de ensalada  
slacentrifuge

Ø cm	Höhe cm	Inhalt ltr.	Ø inch	Art.-Nr.	EAN	GP
27,0	17,0	5,0	10½	13 7007 22 00	4 007371 031356	

Deckel mit Seilzugtechnik für perfektes Trocknen



## Salatschleuder, Edelstahl

salad spinner  
essoreuse à salade  
centrifuga per insalata  
centrifugadora de ensalada  
slacentrifuge

Ø cm	Höhe cm	Inhalt ltr.	Ø inch	Art.-Nr.	EAN	GP
24,0	17,0	3,25	9½	13 7008 28 00	4 007371 031561	

Deckel mit Seilzugtechnik für perfektes Trocknen  
inklusive Basisplatte

Design: Ralph Krämer



## Eierschneider

egg slicer  
coupe-œuf  
tagliauovo  
cortahuevos  
eiersnijder

L/B cm	inch	Art.-Nr.	EAN	GP
15,5 x 9,5	6 x 3¾	13 1026 28 00	4 007371 034463	



## Eipicker

egg pricker  
perçoir à œuf  
forauovo  
punzón huevos  
eierprikker

Ø cm	Höhe cm	Ø inch	Art.-Nr.	EAN	GP
4,0	4,0	1½	13 1027 28 00	4 007371 034470	

24 Stück im attraktiven Verkaufs-Display



## Eierköpfer »Smart«

egg shell topper  
ciseau à œuf  
apriuova  
abre huevos  
ei-onthoofder

L/B cm	inch	Art.-Nr.	EAN	GP
12,0 x 8,5	5 x 3⅓	13 1029 28 00	4 007371 057455	



## Ei-Trenner mit Clip

egg separator incl. fixing clip  
séparateur à œuf  
separa tuorlo  
separador de claras de huevo  
eierscheider

Ø cm	Ø inch	Art.-Nr.	EAN	GP
8,0	3	13 1086 28 00	4 007371 052955	

# Praktische Küchenhelfer

hochwertige Kunststoffe, Edelstahl / high quality plastics, stainless steel



## Schneesläger

egg beater  
bateur à neige  
frusta  
batidor  
slagroomklopper

Länge cm	inch	Art.-Nr.	EAN
31,0	12¼	13 1007 28 00	4 007371 052412



## Käseibe

cheese grater  
râpe à fromage  
grattugia per formaggio  
rallador queso  
kaasrasp

Länge cm	inch	Art.-Nr.	EAN
20,0	7¾	13 1021 28 00	4 007371 032261



## Glaskeramik-Reiniger

ceramic hob cleaner  
spatule pour vitro-céramique  
raschiello pulitura piastre vetroceramica  
espátula con cuchilla  
kookplaatkrabber

L/B cm	inch	Art.-Nr.	EAN
14,5 x 6,0	5¾ x 2½	13 1023 22 00	4 007371 032803

im Display, 24 Stück  
mit 2 Ersatzklingen

Design: Ralph Krämer

<b>Ersatzklingen 10 Stück</b>	<b>13 1023 28 10</b>	4 007371 035743
-------------------------------	----------------------	-----------------



## Glaskeramik-Reiniger

ceramic hob cleaner  
spatule pour vitro-céramique  
raschiello pulitura piastre vetroceramica  
espátula con cuchilla  
kookplaatkrabber

L/B cm	inch	Art.-Nr.	EAN
16,0 x 5,5	6½ x 2	13 1023 00 00	4 007371 056670

12 Stück im attraktiven Verkaufs-Display



<b>Ersatzklingen 10 Stück</b>	<b>13 1023 28 10</b>	4 007371 035743
-------------------------------	----------------------	-----------------



## Dressingshaker

dressing shaker  
dressing shaker  
dressing shaker  
agitador salsa  
dressingshaker

Ø cm	Höhe cm	Inhalt ltr.	inch	Art.-Nr.	EAN
6,0	20,0	0,25	2½	13 1028 28 00	4 007371 034494

mit Rezepten, Deckel aus Edelstahl



## Verschlussklammern, 2er Set

closing clip for food bags  
crochet de fermeture pour sachets  
alimentaires  
mollettone salvafreschezza  
pinza para cerrar bolsas  
vershoudklem

L/H cm	inch	Art.-Nr.	EAN
7,8 x 6,0	3 x 2½	13 1044 28 00	4 007371 038027



 GP = Produkt in farbigem Geschenkkarton

 KE = auf Karte mit Euroloch

# Praktische Küchenhelfer

hochwertige Kunststoffe, Edelstahl / high quality plastics, stainless steel



## Bratenzange/ Schneidehilfe

roast tongs / holder  
pince / fixeur à rôtir  
pinza / fissatore per arrosti  
pinza corta carne  
braadtang / -houder

L/B cm	inch	Art.-Nr.	EAN	
29,0 x 7,0	11½ x 2¾	<b>13 1048 28 00</b>	4 007371 039796	



## Kühlschrank- Geruchskiller

refrigerator odor absorber  
absorbeur d'odeurs pour frigo  
assorbiodori per frigo  
eliminator de malos olores  
koelkastluchtjes-verwijderaar

Ø cm	Höhe cm	Ø inch	Art.-Nr.	EAN	
6,0	6,0	2½	<b>13 1060 28 00</b>	4 007371 043311	

inklusive Kohlefilter;  
**24 Stück im attraktiven Verkaufs-Display**

<b>Kohlefilter einzeln</b>	<b>13 1060 00 01</b>	4 007371 043328
----------------------------	----------------------	-----------------



## Zitronenpresse, klein

lemon/orange squeezer  
presse-agrume  
spremiagrumi  
prensalmiones  
citruspers

Ø cm	Höhe cm	Ø inch	Art.-Nr.	EAN	
9,0	7,0	3½	<b>13 1032 28 00</b>	4 007371 034647	



## Zitronenpresse

lemon/orange squeezer  
presse-agrume  
spremiagrumi  
prensalmiones  
citruspers

Ø cm	Höhe cm	Ø inch	Art.-Nr.	EAN	
13,0	9,0	5	<b>13 6600 28 00</b>	4 007371 022927	



## Universalöffner »Viper«

jar and bottle opener  
ouvre bocal universel  
apritutto universale  
abridor universal  
multi flessenopener

L/B/H cm	inch	Art.-Nr.	EAN	
16,0 x 9,5 x 1,5	6½ x 3¾ x ½	<b>13 1071 28 00</b>	4 007371 047234	



## Sicherheits-Dosenöffner »Easy«

safety can opener  
ouvre boîte  
apriscatole  
abrelatas  
blikopener

L/B cm	inch	Art.-Nr.	EAN	
18,0 x 5,0	7 x 2	<b>13 1080 10 00</b>	4 007371 052436	



## Dosenöffner

can opener  
ouvre boîte  
apriscatole  
abrelatas  
blikopener

Länge cm	inch	Art.-Nr.	EAN
15,0	6	<b>13 1082 00 00</b>	4 007371 059275

**12 Stück im attraktiven Verkaufs-Display**  
farblich sortiert, schwarz, grün, rot  
und orange mit Schutzkappe



**GP** = Produkt in farbigem Geschenkkarton

**KE** = auf Karte mit Euroloch



# Raclette, Fondue und Zubehör

Mit Freunden und Familie schmeckt's nochmal so gut.

In gemütlicher Atmosphäre bereitet jeder köstliche Zutaten ganz individuell nach seinem Geschmack zu. Ob Raclette oder Fondue – Ihrer Kreativität und Phantasie sind keine Grenzen gesetzt.



# Kochen am Tisch – 8er Raclettes

Raclette und Zubehör



**Raclette »Hot Stone«**  
mit Steinplatte  
Raclette

mit 8 Pfännchen  
und 8 Schabern

Art.-Nr. **17 4000 00 00** EAN **GP**

L/B/H cm **47,0 x 24,5 x 13,5** inch **18½ x 9½ x 5½**

Technische Daten  
Betriebsspannung: 230V /~50/60Hz  
Leistungsaufnahme: 1200 Watt  
Pfännchen separat erhältlich **17 4600 00 00**



**Raclette »Grande«**  
mit Grillplatte  
Raclette

mit 8 Pfännchen  
und 8 Schabern

Art.-Nr. **17 5500 00 00** EAN **GP**

L/B/H cm **47,0 x 24,5 x 13,5** inch **18½ x 9½ x 5½**

Technische Daten  
Betriebsspannung: 230V /~50/60Hz  
Leistungsaufnahme: 1200 Watt  
Pfännchen separat erhältlich **17 4600 00 00**



**Raclette »Exclusive«**  
mit Steinplatte und Grillplatte,  
Unterteil Edelstahl  
Raclette

mit 8 Pfännchen  
und 8 Schabern



Art.-Nr. **17 7000 00 00** EAN **GP**

L/B/H cm **47,0 x 24,5 x 13,5** inch **18½ x 9½ x 5½**

Technische Daten  
Betriebsspannung: 230V /~50/60Hz  
Leistungsaufnahme: 1200 Watt  
Pfännchen separat erhältlich **17 4600 00 00**



**Raclette »Style«**  
Raclette

mit 8 Pfännchen  
und 8 Schabern

Art.-Nr. **17 8200 10 00** EAN **GP**

L/B/H cm **53,5 x 20,0 x 11,5** inch **21 x 8 x 4½**

Technische Daten  
Betriebsspannung: 220-240V /~50Hz  
Leistungsaufnahme: 1200 Watt  
Pfännchen separat erhältlich **17 4600 00 00**



**Raclette-Brettchen,  
4er Set**  
raclette saucer  
planchette à raclette  
tabililla raclette  
liston para raclette  
raclette plankje

L/B cm **14,0 x 9,5** inch **5½ x 3¾** Art.-Nr. **17 4800 10 00** EAN **GP**



# Kochen am Tisch – 2er und 4er Raclettes

## Raclette »Hot Stone Duo«

Raclette

mit 2 Pfännchen



Art.-Nr.	EAN	GP
● 17 8000 00 00	4 007371 049665	
● 17 8000 14 00	4 007371 051156	
○ 17 8000 22 00	4 007371 051170	

L/B/H cm	inch
30,0 x 10,5 x 10,0	12 x 4 x 4

Technische Daten

Betriebsspannung: 220V–240V /~50/60Hz

Leistungsaufnahme: 350 – 400 Watt

Pfännchen separat erhältlich **17 8000 00 01**



## Raclette »Hot Stone Quattro«,

Raclette

mit 4 Pfännchen



Art.-Nr.	EAN	GP
● 17 8100 00 00	4 007371 054027	
● 17 8100 14 00	4 007371 054126	
○ 17 8100 22 00	4 007371 057820	

L/B/H cm	inch
50,0 x 10,5 x 10,0	19½ x 4 x 4

Technische Daten

Betriebsspannung: 220V /~50/60Hz

Leistungsaufnahme: 600 Watt

Pfännchen separat erhältlich **17 8000 00 01**

## Raclette-Schaber, 8er Set

raclette spatula  
spatule raclette  
spatola raclette  
rasqueta para raclette  
raclette schraper



L/B/H cm	inch	Art.-Nr.	EAN	GP
13,0 x 4,5	5 x 2	17 4850 10 00	4 007371 047456	

GP = Produkt in farbigem Geschenkkarton

KE = auf Karte mit Euroloch





# Kochen am Tisch – Fondue

	<b>Fondueteller, schwarz</b>	Ø cm	Ø inch	Art.-Nr.	EAN
	fondue plate assiette à fondue piatto per fonduta plato fondue fonduebord	25,0	10	<b>21 1020 10 00</b>	4 007371 049528
		Keramik			

	<b>Fondueteller, weiß</b>	Ø cm	Ø inch	Art.-Nr.	EAN
	fondue plate assiette à fondue piatto per fonduta plato fondue fonduebord	25,0	10	<b>21 1020 22 00</b>	4 007371 049535
		Keramik			

	<b>Caquelon »Appenzell«, schwarz</b>	Ø cm	Ø inch	Art.-Nr.	EAN
	cheese fondue casserole caquelon à fondue casseruola per fonduta cacerola fondue fondue caquelon	24,0	9½	<b>21 2510 10 00</b>	4 007371 046800
		Keramik Inhalt: 1,8 ltr.			

	<b>Sicherheits-Brennpaste</b>	Inhalt	Art.-Nr.	EAN	
	safety fuel paste gel combustible de securite pasta combustibile di sicurezza gel combustible más seguro brandpasta	3 x 80g	<b>21 8000 00 00</b>	4 007371 045155	
		Paste besteht aus Bio-Alkohol			

	<b>Siedelöffel, 2 Stück im Set</b>	Länge cm	inch	Art.-Nr.	EAN
	fondue spoon cuillère à fondue cucchiaio fonduta cazo hervidos chinees fondue netje	22,5	9	<b>10 6269 28 02</b>	4 007371 057219

# Kochen am Tisch – Fleisch-Fondues

Edelstahl rostfrei / stainless steel



## Fondue-Set »St. Moritz«

fondue set  
set de fondue  
servizio fonduta  
set fondue  
fondue set

Ø cm	Höhe cm	Ø inch	Art.-Nr.	EAN	GP
19,0	21,0	7½	21 3000 28 00	4 007371 045063	

**Das Set besteht aus:** Fondue-Topf mit Spritzschutz, Rechaud, Sicherheits-Pastenbrenner, 6 Fleischfonduegabeln  
Inhalt: 1,9 ltr.

Fondue-Topf geeignet für **Induktion**



## Fondue-Set »Lugano«

fondue set  
set de fondue  
servizio fonduta  
set fondue  
fondue set

Ø cm	Höhe cm	Ø inch	Art.-Nr.	EAN	GP
20,0	17,0	8	21 3200 28 00	4 007371 045087	

**Das Set besteht aus:** Fondue-Topf mit Spritzschutz, Rechaud, Sicherheits-Pastenbrenner, 6 Fleischfonduegabeln  
Inhalt: 1,6 ltr.

Fondue-Topf geeignet für **Induktion**



## Fondue-Set »Luzern«

fondue set  
set de fondue  
servizio fonduta  
set fondue  
fondue set

Ø cm	Höhe cm	Ø inch	Art.-Nr.	EAN	GP
17,0	21,5	7	21 3300 28 00	4 007371 045094	

**Das Set besteht aus:** Fondue-Topf mit Spritzschutz, Rechaud, Sicherheits-Pastenbrenner, 6 Fleischfonduegabeln  
Inhalt: 1,6 ltr.

Fondue-Topf geeignet für **Induktion**



## Fondue-Set »Zürich«

fondue set  
set de fondue  
servizio fonduta  
set fondue  
fondue set

Ø cm	Höhe cm	Ø inch	Art.-Nr.	EAN	GP
19,5	19,5	7½	21 3400 28 00	4 007371 045100	

**Das Set besteht aus:** Fondue-Topf mit Spritzschutz, Rechaud, Sicherheits-Pastenbrenner, 6 Fleischfonduegabeln  
Inhalt: 2,0 ltr.

Fondue-Topf geeignet für **Induktion**

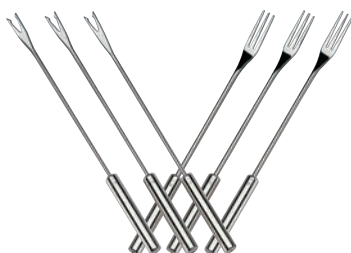

## Fonduegabeln »Beef« und »Cheese«, 6er Set

fondue forks  
fourchettes à fondue  
forchetta per fonduta inox  
tenedores fondue  
fonduevorkjes edelstaal

	Länge cm	inch	Art.-Nr.	EAN	GP
Fleisch/meat	26,0	10	21 4000 28 06	4 007371 045285	
Käse/cheese	26,0	10	21 4100 28 06	4 007371 045292	

# Kochen am Tisch – Zubehör



Tellerwärmer

Tellerwärmer



## Tellerwärmer »XL«

plate warmer  
chauffe-assiettes  
scaldapiatti  
calentador de platos  
bordenwarmer

L/B cm	inch	Art.-Nr.	EAN	
200,0 x 30,0	78½ x 12	17 0160 12 00	4 007371 050609	

### Technische Daten

Betriebsspannung: 220V–240V /~50/60Hz

Leistungsaufnahme: 200 Watt

für bis zu 12 Menüteller max. 32cm



# Crème Brûlée

Eine typische Crème Brûlée mit einer knusprig karamellisierten Zuckerschicht wird für Sie zum Kinderspiel. Die passenden Förmchen für ein stilvolles Servieren finden Sie in unseren attraktiven Geschenksets. Mit dem Gasbrenner, der mit handelsüblichem Butangas gefüllt werden kann, können Sie den Zucker punktgenau nach Ihrem persönlichen Geschmack schmelzen lassen. Ganz so wie bei den Profi-Köchen. Ihre Gäste werden beeindruckt sein.



# Crème Brûlée



## Crème Brûlée Gas-Brenner »Classic«

gas torch  
brûleur de gaz  
becco del gas  
mechero de gas  
gasbrander

Höhe cm	inch	Art.-Nr.	EAN
15,5	6	19 1000 10 00	4 007371 038607

regelbare Leistung:  
233 W



## Crème Brûlée Gas-Brenner »Chef«

gas torch  
brûleur de gaz  
becco del gas  
mechero de gas  
gasbrander

Höhe cm	inch	Art.-Nr.	EAN
15,5	6	19 1900 10 00	4 007371 057363

regelbare Leistung:  
321 W



## Crème Brûlée Gas-Brenner »Profi«

gas torch  
brûleur de gaz  
becco del gas  
mechero de gas  
gasbrander

Höhe cm	inch	Art.-Nr.	EAN
18,0	7	19 2000 38 00	4 007371 038614

regelbare Leistung:  
412 W



## Crème Brûlée Set, 7-teilig

Crème brûlée set

Höhe Brenner cm	inch	Art.-Nr.	EAN
15,5	6	19 2500 28 07	4 007371 043304

bestehend aus einem Crème Brûlée Brenner (233 W) und  
6 ovalen Porzellan-Schälchen



## Crème Brûlée Set »Eco«, schwarz, 5-teilig

Crème brûlée set

Höhe Brenner cm	inch	Art.-Nr.	EAN
15,5	6	19 2800 10 05	4 007371 050524

bestehend aus einem Crème Brûlée Brenner (233 W) und  
4 ovalen Porzellan-Schälchen



## Crème Brûlée Schälchen oval, 6er Set

Crème Brûlée dish  
moule à Crème Brûlée  
scodella Crème Brûlée  
bol para crema catalana  
Crème Brûlée schaalte

L/B/H cm	inch	Art.-Nr.	EAN
13,0 x 8,0 x 2,5	5 x 3 x 1	19 2500 00 06	4 007371 043816

hitzebeständig bis 280°C



# Edelstahl-Töpfe und Sonstiges

Das Kochgeschirr von Küchenprofi zeichnet sich durch den verkapselten Mehrschicht-Boden aus, der für alle Herdarten, sogar für Induktion geeignet ist. Bewährte Materialien wie rostfreier Edelstahl und hitzebeständiges Glas garantieren ein langlebiges Kochvergnügen.





# Edelstahl-Kochgeschirr

mit extra starkem Mehrschichtboden

für alle Herdarten geeignet:

■ Glaskeramik ■ Induktion ■ Halogen ■ Elektro ■ Gas



## Topf-Set »Siena«, 4-teilig

pot set, 4 pcs.  
ensemble de cocottes, 4 pcs.  
batteria di pentole, da 4 pezzi  
batería de cocina, 4 piezas  
pannenset, 4 delig

	Art.-Nr.	EAN	
geeignet für Induktion	<b>23 8000 28 04</b>	4 007371 043700	

Set besteht aus:  
Fleischtopf Ø 16,0 cm, mit Glasdeckel, Inhalt: 1,25 ltr.  
Fleischtopf Ø 20,0 cm, mit Glasdeckel, Inhalt: 2,5 ltr.  
Bratentopf Ø 20,0 cm, mit Glasdeckel, Inhalt: 3,0 ltr.  
Fleischtopf Ø 24,0 cm, mit Glasdeckel, Inhalt: 5,5 ltr.



## Pastatopf, mit Einsatz

pasta pot  
marmite à pâtes  
pasta pentola  
olla para pasta  
pasta pan

Ø cm	H cm	Inhalt ltr.	Ø inch	Art.-Nr.	EAN	
24,0	18,5	7,5	9½	<b>23 8050 28 24</b>	4 007371 053266	

mit verkapseltem Mehrschichtboden, Edelstahlinsatz und Glasdeckel  
geeignet für **Induktion**



## Aromabräter mit Glasdeckel

roasting pan with seasoning lid  
rôtissoire avec couvercle d'arôme  
brasiera con coperchio di aroma  
bandeja para rustidos con tapa para sazonar  
braadslede met glasdeksel

L/B/H cm	Inhalt ltr.	inch	Art.-Nr.	EAN	
36 x 24 x 10	6,0	14 x 9½ x 4	<b>23 8600 28 36</b>	4 007371 050722	

mit Gittereinsatz  
geeignet für Elektro, Gas, Glaskeramik, **Induktion** und Backofen



## Multibräter, 3-teilig

roasting pan set, 3 pcs.  
universelle rôtissoire  
brasiera multiuso  
set de bandeja para rustidos  
braadslede multifunctioneel

L/B/H cm	Inhalt ltr.	inch	Art.-Nr.	EAN	
36 x 24 x 10	6,0	14 x 9½ x 4	<b>23 8650 28 03</b>	4 007371 050739	

mit Gittereinsatz  
geeignet für Elektro, Gas, Glaskeramik, **Induktion** und Backofen



## Bayrischer Bräter, mit Sandwichboden

lasagne / roast-pan, sandwich bottom  
braisière profi, fond multi-couches  
tegame rettangolare, fondo multistrato  
placa asar profi, fondo sandwich  
ovenschaal, sandwich bodem

L/B/H cm	inch	Art.-Nr.	EAN
32,0 x 20,0 x 6,5	12¾ x 8 x 2½	<b>10 7000 28 32</b>	4 007371 035002
35,0 x 25,5 x 6,5	13¾ x 10 x 2½	<b>10 7000 28 35</b>	4 007371 035019
40,0 x 26,0 x 6,5	15¾ x 10½ x 2½	<b>10 7000 28 40</b>	4 007371 035026

geeignet für Elektro, Gas, Glaskeramik, **Induktion** und Backofen



## Deckel zu Bayrischem Bräter

lid for roast-pan  
couvercle pour braisière  
coperchio per tegame  
tapa para placa asar  
deksel voor braadslede

L/B/H cm	inch	Art.-Nr.	EAN
35,0 x 25,5 x 6,5	13¾ x 10 x 2½	<b>10 7001 28 35</b>	4 007371 038621
40,0 x 26,0 x 6,5	15¾ x 10½ x 2½	<b>10 7001 28 40</b>	4 007371 038638



## Bayrischer Bräter-Set

lasagne / roast-pan, sandwich bottom  
braisière profi, fond multi-couches  
tegame rettangolare, fondo multistrato  
placa asar profi, fondo sandwich  
ovenschaal, sandwich bodem

L/B/H cm	inch	Art.-Nr.	EAN
35,0 x 25,5 x 11,0	13¾ x 10 x 4½	<b>10 7010 28 35</b>	4 007371 039253
40,0 x 26,0 x 11,0	15¾ x 10½ x 4½	<b>10 7010 28 40</b>	4 007371 039260

geeignet für Elektro, Gas, Glaskeramik, **Induktion** und Backofen

# Edelstahl-Kochgeschirr, Schüsseln

mit extra starkem Mehrschichtboden



## Butterpfännchen

butter melter  
casserole à beurre  
pentolino per burro  
cazo salsa  
boterpannetje

Ø cm	Inhalt ltr.	Ø inch	Art.-Nr.	EAN
10,0	0,25	4	23 7000 28 10	4 007371 051569
12,0	0,5	4½	23 7000 28 12	4 007371 051576

mit Innenskalierung  
geeignet für **Induktion**  
(abhängig vom Mindestdurchmesser der Topferkennung)



## Stielkasserolle

saucepan  
poêlon  
casseruola  
cazo  
steelpan

Ø cm	Inhalt ltr.	Ø inch	Art.-Nr.	EAN
14,0	0,7	5½	23 7050 28 14	4 007371 051583
16,0	1,0	6½	23 7050 28 16	4 007371 051590

mit Innenskalierung  
geeignet für **Induktion**



## Wasserbad-Topf, 3-teilig

double boiler  
casserole bain marie  
casseruola per bagno maria  
olla para el baño maria  
au-bain-marie pan

Ø cm	Ø inch	Art.-Nr.	EAN
14,0	5½	23 7060 28 14	4 007371 054287

mit Innenskalierung  
Inhalt Topf: 1,5 L, Inhalt Einsatz: 1,0 ltr.  
Gesamthöhe: 19 cm, Höhe Einsatz: 13 cm  
inklusive Glasdeckel; geeignet für **Induktion**



## Mini-Töpfchen

mini pot  
casserole mini  
pentolina  
olla pequeña  
kookpan klein

Ø cm	Höhe cm	Inhalt ltr.	Ø inch	Art.-Nr.	EAN
12,0	6,5	0,65	4¾	23 7070 28 12	4 007371 053839
14,0	6,5	1,0	5½	23 7070 28 14	4 007371 053846
16,0	7,5	1,5	6¼	23 7070 28 16	4 007371 053853

geeignet für **Induktion**



## Rührschüssel, rutschfest

mixing bowl  
bol à mixer  
ciotola  
fuente  
kom

Ø cm	Höhe cm	Inhalt ltr.	Ø inch	Art.-Nr.	EAN
16	9,5	1,5	6½	25 0540 28 16	4 007371 060738
20	12,0	2,6	8	25 0540 28 20	4 007371 060745
24	15,0	4,8	9½	25 0540 28 24	4 007371 060752



## Schüssel

mixing bowl  
bol à mixer  
ciotola  
fuente  
kom

Ø cm	Höhe cm	Inhalt ltr.	Ø inch	Art.-Nr.	EAN
18,0	6,0	1,0	7	25 0550 28 18	4 007371 051187
22,0	8,0	2,0	8½	25 0550 28 22	4 007371 051194
26,0	9,0	3,0	10	25 0550 28 26	4 007371 051200
30,0	10,5	5,5	12	25 0550 28 30	4 007371 051217



# Siebe, Seiher, Schüsseln

Edelstahl rostfrei / stainless steel



## Rundschüssel, mit 2 Griffen

mixing bowl with side-handles  
bol à mixer rond avec 2 poignées  
bastardelle 2 manici  
fuente amasar redonda con 2 asas  
beslagkom met 2 grepen

Ø cm	Ø inch	Art.-Nr.	EAN
22,0	9	25 0500 28 22	4 007371 028912

### Standring zur Rundschüssel

15,0	6	25 0700 10 00	4 007371 028943
------	---	---------------	-----------------



## Passiersieb mit Griff

single arm colander  
tamis-passoire à poignée  
passino  
pasador con mango  
vergiert met steel

Ø cm	Ø inch	Art.-Nr.	EAN
18,0	7	25 0100 28 18	4 007371 030755



## Brühsieb mit Griff

single arm colander  
tamis à ébouillanter  
colapasta emisférico  
colador caldo  
vergiert met steel

Ø cm	Ø inch	Art.-Nr.	EAN
20,0	8	25 0200 28 20	4 007371 028820



## Gemüseseiher

standing colander  
égouttoir sur pieds  
colapasta  
escurreverduras  
vergiert

Ø cm	Ø inch	Art.-Nr.	EAN
24,0	9½	25 0350 28 24	4 007371 047111
26,0	10½	25 0350 28 26	4 007371 048743



## Seiher »Innova«, klappbar

colander foldable  
passoire en silicone pliante  
scolapasta pieghevole  
colador plegable  
vergiert inklapbaar

	Ø cm	Ø inch	Art.-Nr.	EAN	GP
schwarz	22,0	8½	25 0510 10 22	4 007371 053600	
grün	22,0	8½	25 0510 11 22	4 007371 055536	
rot	22,0	8½	25 0510 14 22	4 007371 053624	



	Ø cm	Ø inch	Art.-Nr.	EAN	GP
schwarz	25,0	10	25 0510 10 25	4 007371 053617	
grün	25,0	10	25 0510 11 25	4 007371 055543	
rot	25,0	10	25 0510 14 25	4 007371 053631	





# Scheren und Schneidebretter

Scharfe Klingen und ergonomische Griffe sorgen für komfortables Schneiden. Die innovativen Kräuterscheren mit mehreren hintereinander liegenden Klingen erleichtern das Zerkleinern von frischen Kräutern.

Qualitativ hochwertige Kunststoff-Schneidebretter dürfen in keiner Küche fehlen. Sie sind hygienisch, geschmacks- und geruchsneutral, messerschonend und unzerbrechlich.



# Scheren

Edelstahl rostfrei / stainless steel

Scheren

## Haushaltsschere XS »Titanium«

kitchen scissors  
ciseaux de cuisine  
forbice di cucina  
tijeras cocina  
keukenschaar



Länge cm	inch	Art.-Nr.	EAN	
14,0	5½	23 9920 28 00	4 007371 051729	

Titan-Beschichtung, mit Soft Grip Einlage

## Haushaltsschere M »Titanium«

kitchen scissors  
ciseaux de cuisine  
forbice di cucina  
tijeras cocina  
keukenschaar



Länge cm	inch	Art.-Nr.	EAN	
21,0	8½	23 9921 28 00	4 007371 051743	

Titan-Beschichtung, mit Soft Grip Einlage

## Haushaltsschere L »Titanium«

kitchen scissors  
ciseaux de cuisine  
forbice di cucina  
tijeras cocina  
keukenschaar



Länge cm	inch	Art.-Nr.	EAN	
25,0	10	23 9922 28 00	4 007371 051750	

Titan-Beschichtung, mit Soft Grip Einlage

## Kräuterschere »Titanium«

herb scissors  
ciseaux à herbes  
forbice per erbe  
tieras corta-hierbas  
kruidenschaar



Länge cm	inch	Art.-Nr.	EAN	
19,0	7½	23 9925 28 00	4 007371 055024	

inklusive Reinigungskamm  
mit 5-fach Klinge  
Titan-Beschichtung, mit Soft Grip Einlage

## Geflügelschere

poultry scissors  
cisailles à volaille  
trinciapolli  
tijeras aves  
gevogelte-schaar



Länge cm	inch	Art.-Nr.	EAN	
25,0	10	09 2300 28 00	4 007371 034906	

mit Sicherheitsverschluss

## Geflügelschere »Profi«

poultry scissors  
cisailles à volaille  
trinciapolli  
tijeras aves  
gevogelte-schaar



Länge cm	inch	Art.-Nr.	EAN	
24,0	9½	09 2350 28 00	4 007371 047685	

mit Sicherheitsverschluss







# Scheren

Edelstahl rostfrei / stainless steel



## Küchenschere

kitchen scissors  
ciseaux de cuisine  
forbice di cucina  
tijeras cocina  
keukenschaar



	Länge cm	inch	Art.-Nr.	EAN	
	19,0	7½	23 9900 28 00	4 007371 036856	
	19,0	7½	23 9900 11 00	4 007371 060561	
	19,0	7½	23 9900 14 00	4 007371 060578	



## Küchenschere

kitchen scissors  
ciseaux de cuisine  
forbice di cucina  
tijeras cocina  
keukenschaar



	Länge cm	inch	Art.-Nr.	EAN	
	20,0	8	23 9950 28 00	4 007371 042666	

## Kräuterschere

herb scissors  
ciseaux à herbes  
forbice per erbe  
tieras corta-hierbas  
kruidenschaar







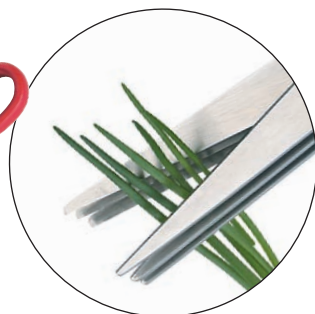

	Länge cm	inch	Art.-Nr.	EAN	
	20,0	8	23 9910 28 00	4 007371 048446	

mit 3-fach Klinge

## Kräuterschere

herb scissors  
ciseaux à herbes  
forbice per erbe  
tieras corta-hierbas  
kruidenschaar



	Länge cm	inch	Art.-Nr.	EAN	
	20,0	8	23 9910 11 00	4 007371 061087	
	20,0	8	23 9910 14 00	4 007371 061094	







mit 3-fach Klinge





# Schneidebretter

hochwertiger Kunststoff / high quality plastics

	<b>Frühstücksbrett, weiß</b>  breakfast board planche à tartiner tagliere colazione bandeja ontbijt plankje	L/B cm	inch	Art.-Nr.	EAN
		25,0 x 16,5	10 x 6	<b>23 2516 22 00</b>	4 007371 039505
	<b>Schneidebrett, weiß</b>  cutting board planche à découper tagliere tabla cortar snijplankje	L/B cm	inch	Art.-Nr.	EAN
	mit Metallgriff	27,0 x 20,0	10½ x 8	<b>23 2720 22 00</b>	4 007371 039567
	<b>Schneidebrett, weiß, mit Saftrille</b>  cutting board planche à découper tagliere tabla cortar snijplankje met sapgeul	L/B cm	inch	Art.-Nr.	EAN
	mit Metallgriff	36,0 x 26,0	14 x 10	<b>23 3626 22 00</b>	4 007371 039598
	<b>Frühstücksbrett, granit</b>  breakfast board planche à tartiner tagliere colazione bandeja ontbijt plankje	L/B cm	inch	Art.-Nr.	EAN
		25,0 x 16,5	10 x 6	<b>23 2516 50 00</b>	4 007371 039512
	<b>Schneidebrett, granit</b>  cutting board planche à découper tagliere tabla cortar snijplankje	L/B cm	inch	Art.-Nr.	EAN
	mit Metallgriff	27,0 x 20,0	10½ x 8	<b>23 2720 50 00</b>	4 007371 039574
	<b>Schneidebrett, granit, mit Saftrille</b>  cutting board planche à découper tagliere tabla cortar snijplankje met sapgeul	L/B cm	inch	Art.-Nr.	EAN
	mit Metallgriff	36,0 x 26,0	14 x 10	<b>23 3626 50 00</b>	4 007371 039604



GP = Produkt in farbigem Geschenkkarton



KE = auf Karte mit Euroloch

# Schneidebretter

hochwertiger Kunststoff / high quality plastics



## Schneidebrett »Colore«, rot

cutting board  
planche à découper  
tagliere  
tabla cortar  
snijplankje met sappeul

L/B/H cm	inch	Art.-Nr.	EAN
25,0 x 15,0 x 0,9	10 x 6 x 1/8	23 1000 14 25	4 007371 060769
29,0 x 20,0 x 0,9	11 1/2 x 8 x 1/8	23 1000 14 29	4 007371 060776
36,5 x 25,0 x 1,0	14 1/2 x 10 x 1/8	23 1000 14 36	4 007371 060783
42,0 x 29,0 x 1,0	16 1/2 x 11 1/2 x 1/8	23 1000 14 42	4 007371 060790

## Schneidebrett »Colore«, weiß

cutting board  
planche à découper  
tagliere  
tabla cortar  
snijplankje met sappeul



L/B/H cm	inch	Art.-Nr.	EAN
25,0 x 15,0 x 0,9	10 x 6 x 1/8	23 1000 22 25	4 007371 060806
29,0 x 20,0 x 0,9	11 1/2 x 8 x 1/8	23 1000 22 29	4 007371 060813
36,5 x 25,0 x 1,0	14 1/2 x 10 x 1/8	23 1000 22 36	4 007371 060820
42,0 x 29,0 x 1,0	16 1/2 x 11 1/2 x 1/8	23 1000 22 42	4 007371 060837



## Schneidebrett »Colore«, granit

cutting board  
planche à découper  
tagliere  
tabla cortar  
snijplankje met sappeul



L/B/H cm	inch	Art.-Nr.	EAN
25,0 x 15,0 x 0,9	10 x 6 x 1/8	23 1000 50 25	4 007371 060844
29,0 x 20,0 x 0,9	11 1/2 x 8 x 1/8	23 1000 50 29	4 007371 060851
36,5 x 25,0 x 1,0	14 1/2 x 10 x 1/8	23 1000 50 36	4 007371 060868
42,0 x 29,0 x 1,0	16 1/2 x 11 1/2 x 1/8	23 1000 50 42	4 007371 060875



# Würzen und mehr

Gewürze – im praktischen Drehständer immer griffbereit zur Hand.

Ganz nebenbei durch attraktiven Material-Mix ein optisches Highlight in jeder Küche.





# Gewürzständer



## Edelstahl-Gewürzständer, drehbar

revolving spice rack, wood  
présentoir épices, bois  
portaspezie legno  
soporte especias, haya  
houten kruiden standaard

Höhe cm	inch	Art.-Nr.	EAN
30,0	12	26 0300 28 16	4 007371 058865

rund,  
ungefüllt mit Aufklebern

## Holz-Gewürzständer

revolving spice rack, wood, filled  
présentoir épices, bois, rempli  
portaspezie legno, ripieno  
soporte especias, haya, lleno  
houten kruiden standaard, gevuld

Höhe cm	inch	Art.-Nr.	EAN
23,0	9	26 0400 10 12	4 007371 058780

rund,  
gefüllt mit 12 verschiedenen Gewürzen



## Holz-Gewürzständer

revolving spice rack, wood, filled  
présentoir épices, bois, rempli  
portaspezie legno, ripieno  
soporte especias, haya, lleno  
houten kruiden standaard, gevuld

Höhe cm	inch	Art.-Nr.	EAN
28,0	11	26 0400 10 16	4 007371 058797

rund,  
gefüllt mit 16 verschiedenen Gewürzen



# Gewürzständer



## Gewürzständer, drehbar

revolving spice rack, wood, filled  
présentoir épices, bois, rempli  
portaspezie legno, ripieno  
soporte especias, haya, lleno  
houten kruiden standaard, gevuld

Höhe cm	inch	Art.-Nr.	EAN	
30,0	12	26 0500 28 16	4 007371 041638	

rund, Holz mit Edelstahl kombiniert,  
gefüllt mit 16 verschiedenen Gewürzen

<b>Gewürzglas einzeln, leer</b>	26 0050 00 00	4 007371 030731
---------------------------------	---------------	-----------------



## Gewürzständer, drehbar

revolving spice rack, wood, filled  
présentoir épices, bois, rempli  
portaspezie legno, ripieno  
soporte especias, haya, lleno  
houten kruiden standaard, gevuld

Höhe cm	inch	Art.-Nr.	EAN	
30,0	12	26 0550 28 16	4 007371 048286	

rund, Holz mit Edelstahl kombiniert,  
gefüllt mit 16 verschiedenen Gewürzen

<b>Gewürzglas einzeln, leer</b>	26 0050 00 00	4 007371 030731
---------------------------------	---------------	-----------------



## Gewürzständer

spice rack, wood, filled  
présentoir épices, rempli  
portaspezie, ripieno  
soporte especias, lleno  
houten kruiden standaard, gevuld

L/B/H cm	inch	Art.-Nr.	EAN	
29,5 x 9,0 x 21,5	11½ x 3½ x 8½	26 0750 28 12	4 007371 048736	

Holz mit Edelstahl kombiniert,  
zum Stellen oder Aufhängen (inklusive Dübel und Schrauben),  
gefüllt mit 12 verschiedenen Gewürzen

<b>Gewürzglas einzeln, leer</b>	26 0050 00 00	4 007371 030731
---------------------------------	---------------	-----------------

# Pfeffer- und Salzmühlen



KÜCHENPROFI

- gefüllt mit Pfeffer und Salz
- mit hochwertigem Keramik-Mahlwerk
- 20 Jahre Garantie auf das Mahlwerk



## Meersalz

sea salt  
sel de mer  
sale marino  
sal marina  
zeezout

Inhalt	Art.-Nr.	EAN
250 g	30 0100 00 00	4 007371 029544



## Schwarzer Pfeffer

black pepper  
poivre noir  
pepe nero  
pimienta negra  
zwarte peper

Inhalt	Art.-Nr.	EAN
100 g	30 0105 00 00	4 007371 032124



## Mini-Streuer, 4er Set

dredger, 4 pcs. set  
saupoudreur, 4 pcs.  
spargitutto, set 4 pz.  
esparcidor, 4 pzs.  
strooier, 4 stuks

L/B/H cm	inch	Art.-Nr.	EAN	GP
3,0 x 3,0 x 4,0	1 x 1 x 1½	30 1200 66 00	4 007371 040853	



## Midi-Mühlen Set Acryl

pepper mill, salt mill  
moulin à poivre, moulin à sel  
macinapepe, macinasale  
molinillo de pimienta, molinillo de sal  
pepermolen, zoutmolen

L/B/H cm	inch	Art.-Nr.	EAN	GP
3,5 x 3,5 x 8,5	1½ x 1½ x 3½	30 4270 66 00	4 007371 044011	

## Pfeffer- & Salzmühlen-Set Acryl

pepper mill, salt mill  
moulin à poivre, moulin à sel  
macinapepe, macinasale  
molinillo de pimienta, molinillo de sal  
pepermolen, zoutmolen

Ø cm	Höhe cm	Ø inch	Art.-Nr.	EAN	GP
4,5	14,0	5½	30 4290 66 00	4 007371 045506	



## Pfeffer- & Salzmühle Acryl

pepper mill, salt mill  
moulin à poivre, moulin à sel  
macinapepe, macinasale  
molinillo de pimienta, molinillo de sal  
pepermolen, zoutmolen

	Höhe cm	inch	Art.-Nr.	EAN	GP
Pfefermühle	14,5	6	30 2006 66 00	4 007371 032889	
Salzmühle	14,5	6	30 2007 66 00	4 007371 032896	



GP = Produkt in farbigem Geschenkkarton

KE = auf Karte mit Euroloch

Würzen und mehr



# Pfeffer- und Salzmühlen

- gefüllt mit Pfeffer und Salz
- mit hochwertigem Keramik-Mahlwerk
- 20 Jahre Garantie auf das Mahlwerk

## Pfeffer- & Salzmühle, Acryl

pepper mill, salt mill  
moulin à poivre, moulin à sel  
macinapepe, macinasale  
molinillo de pimienta, molinillo de sal  
pepermolen, zoutmolen



	Höhe cm	inch	Art.-Nr.	EAN
Pfeffermühle	10,5	4	30 8003 66 00	4 007371 046213
Salzmühle	10,5	4	30 8004 66 00	4 007371 046220

### »Family Mini«

## Pfeffer- & Salzmühle, Acryl

pepper mill, salt mill  
moulin à poivre, moulin à sel  
macinapepe, macinasale  
molinillo de pimienta, molinillo de sal  
pepermolen, zoutmolen



	Höhe cm	inch	Art.-Nr.	EAN
Pfeffermühle	14,0	5½	30 8000 66 00	4 007371 035224
Salzmühle	14,0	5½	30 8001 66 00	4 007371 035231

### »Family Maxi«

## Pfeffer- & Salzmühle Acryl/Chrom

pepper mill, salt mill  
moulin à poivre, moulin à sel  
macinapepe, macinasale  
molinillo de pimienta, molinillo de sal  
pepermolen, zoutmolen



	Höhe cm	inch	Art.-Nr.	EAN	GP
Set	13,0	5	30 4415 38 00	4 007371 046589	

### »New York«

## Pfeffer- & Salzmühle Acryl/Chrom

pepper mill, salt mill  
moulin à poivre, moulin à sel  
macinapepe, macinasale  
molinillo de pimienta, molinillo de sal  
pepermolen, zoutmolen



	Höhe cm	inch	Art.-Nr.	EAN	GP
Pfeffermühle	18,0	7	30 4416 38 00	4 007371 046596	
Salzmühle	18,0	7	30 4417 38 00	4 007371 046602	
Set	18,0	7	30 4418 38 00	4 007371 048255	

### »Manhattan«

## Pfeffer- & Salzmühlen-Set, Acryl/Chrom

pepper mill, salt mill  
moulin à poivre, moulin à sel  
macinapepe, macinasale  
molinillo de pimienta, molinillo de sal  
pepermolen, zoutmolen



	Ø cm	Höhe cm	Ø inch	Art.-Nr.	EAN	GP
	4,5	14,0	5½	30 4430 38 00	4 007371 050982	

### »Montreal«

# Pfeffer- und Salzmühlen



KÜCHENPROFI

- gefüllt mit Pfeffer und Salz
- mit hochwertigem Keramik-Mahlwerk
- 20 Jahre Garantie auf das Mahlwerk



## Mini-Mühlen Set Edelstahl/Acryl

pepper mill, salt mill  
moulin à poivre, moulin à sel  
macinapepe, macinasale  
molinillo de pimienta, molinillo de sal  
pepermolen, zoutmolen

Ø cm	Höhe cm	Ø inch	Art.-Nr.	EAN
3,0	5,5	2	30 4250 28 00	4 007371 041553

»Sydney«



## Mini-Mühlen Set Edelstahl/Acryl

pepper mill, salt mill  
moulin à poivre, moulin à sel  
macinapepe, macinasale  
molinillo de pimienta, molinillo de sal  
pepermolen, zoutmolen

Höhe cm	inch	Art.-Nr.	EAN
schwarz 5,5	2	30 4250 10 00	4 007371 060387
weiß 5,5	2	30 4250 22 00	4 007371 060394

»Sydney«



## Peffer- und Salzmühle, Edelstahl/Acryl, mit zwei Mahlwerken

pepper and salt mill  
moulin à poivre, moulin à sel  
macinapepe, macinasale  
molinillo de pimienta, molinillo de sal  
pepermolen, zoutmolen

Ø cm	Höhe cm	Ø inch	Art.-Nr.	EAN
3,0	10,5	2	30 4251 28 00	4 007371 060424

»Sydney«



## Peffer- und Salzmühle, Edelstahl/Acryl, lackiert, mit zwei Mahlwerken

pepper and salt mill  
moulin à poivre, moulin à sel  
macinapepe, macinasale  
molinillo de pimienta, molinillo de sal  
pepermolen, zoutmolen

Höhe cm	inch	Art.-Nr.	EAN
schwarz 10,5	2	30 4251 10 00	4 007371 060400
weiß 10,5	2	30 4251 22 00	4 007371 060417

»Sydney«



## Midi-Mühlen Set Edelstahl/Acryl

pepper mill, salt mill  
moulin à poivre, moulin à sel  
macinapepe, macinasale  
molinillo de pimienta, molinillo de sal  
pepermolen, zoutmolen

Ø cm	Höhe cm	Ø inch	Art.-Nr.	EAN
3,5	8,5	3½	30 4255 28 00	4 007371 045490

»Vienna«



## Pfeffer- & Salzmühle Edelstahl/Acryl

pepper mill, salt mill  
moulin à poivre, moulin à sel  
macinapepe, macinasale  
molinillo de pimienta, molinillo de sal  
pepermolen, zoutmolen

Höhe cm	inch	Art.-Nr.	EAN
Pfeffermühle 16,0	6½	30 1170 28 00	4 007371 039314
Salzmühle 16,0	6½	30 1171 28 00	4 007371 039321

»Milano«

Würzen und mehr



# Pfeffer- und Salzmühlen

- gefüllt mit Pfeffer und Salz
- mit hochwertigem Keramik-Mahlwerk
- 20 Jahre Garantie auf das Mahlwerk



## Pfeffer- & Salzmühle Edelstahl/Acryl

pepper mill, salt mill  
moulin à poivre, moulin à sel  
macinapepe, macinasale  
molinillo de pimienta, molinillo de sal  
pepermolen, zoutmolen

	Höhe cm	inch	Art.-Nr.	EAN	GP
Pfeffermühle	16,0	6½	30 8008 66 00	4 007371 060509	
Salzmühle	16,0	6½	30 8009 66 00	4 007371 060677	

### »Memphis«

## Chilimühle

chili mill  
moulin à piment  
macinapeperoncino  
molinillo de aji  
chilimolen



Ø cm	Höhe cm	Ø inch	Art.-Nr.	EAN	GP
5,0	19,0	2 x 7½	30 8011 28 00	4 007371 060950	

### »San Antonio«

## Pfeffermühle & Salzstreuer Edelstahl/Acryl

pepper mill/salt shaker  
moulin à poivre/salière  
macinapepe/spargisale  
molinillo de pimienta/salero  
pepermolen/zoutstrooier



Ø cm	Höhe cm	Ø inch	Art.-Nr.	EAN	GP
4,0	12,5	5	30 4300 28 00	4 007371 040921	
4,5	17,5	7	30 4350 28 00	4 007371 040938	

### »London«

Pfeffermühle mit integriertem Salzstreuer

## Pfeffer- und Salzmühle, Acryl/Chrom, mit zwei Mahlwerken

pepper and salt mill  
moulin à poivre et sel  
macinapepe & sale  
molinillo de pimienta & sal  
peper & zoutmolen



Ø cm	Höhe cm	Ø inch	Art.-Nr.	EAN	GP
9,0	11,5	3½	30 4420 38 00	4 007371 049504	

### »Houston«



Die Mühle ist mit zwei getrennten, hochwertigen Keramik-Mahlwerken ausgestattet.  
Einstellschrauben für feines oder grobes Mahlen.

## Pfeffer- und Salzmühle, Edelstahl/Acryl, mit zwei Mahlwerken

pepper and salt mill  
moulin à poivre et sel  
macinapepe & sale  
molinillo de pimienta & sal  
peper & zoutmolen



Ø cm	Höhe cm	Ø inch	Art.-Nr.	EAN	GP
6,0	13,5	2½	30 4440 28 00	4 007371 054515	

### »Trattoria«

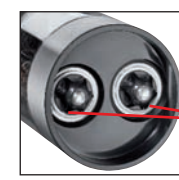

Die Mühle ist mit zwei getrennten, hochwertigen Keramik-Mahlwerken ausgestattet.  
Einstellschrauben für feines oder grobes Mahlen.

GP = Produkt in farbigem Geschenkkarton

KE = auf Karte mit Euroloch





# Praktische Küchenhelfer

Edelstahl rostfrei / stainless steel

## Pfeffer- & Salzmühle Edelstahl

pepper mill, salt mill  
moulin à poivre, moulin à sel  
macinapepe, macinasale  
molinillo de pimienta, molinillo de sal  
pepermolen, zoutmolen







	Höhe cm	inch	Art.-Nr.	EAN	
Pfeffermühle	11,5	4½	30 4400 28 12	4 007371 041515	
Salzmühle	11,5	4½	30 4401 28 12	4 007371 041522	

»Tavola«

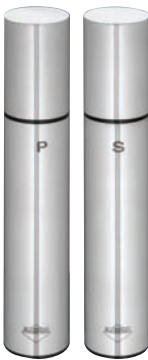
## Pfeffer- & Salzmühle Edelstahl

pepper mill, salt mill  
moulin à poivre, moulin à sel  
macinapepe, macinasale  
molinillo de pimienta, molinillo de sal  
pepermolen, zoutmolen





	Höhe cm	inch	Art.-Nr.	EAN	
Pfeffermühle	19,0	7½	30 4400 28 19	4 007371 041492	
Salzmühle	19,0	7½	30 4401 28 19	4 007371 041508	

»Tavola«

## elektrische Pfeffermühle, Edelstahl/Acryl

electric pepper & salt mill  
moulin à poivre & sel électrique  
macinapepe & macinasale elettrico  
molinillo pimienta & sal eléctrico  
peper & zoutmolen elektrisch



	Höhe cm	inch	Art.-Nr.	EAN	
	16,0	6	30 4070 28 00	4 007371 043601	



»Toscana«

mit LED-Licht  
inklusive Batterien

## elektrisches Pfeffer- & Salzmühlen-Set, Edelstahl/Acryl

electric pepper & salt mill  
moulin à poivre & sel électrique  
macinapepe & macinasale elettrico  
molinillo pimienta & sal eléctrico  
peper & zoutmolen elektrisch



	Höhe cm	inch	Art.-Nr.	EAN	
	16,0	6	30 4072 28 00	4 007371 047791	

»Toscana«

mit LED-Licht  
inklusive Batterien

# Werbemittel

**Sprechen Sie uns auf Ihre optimale Warenpräsentation an!  
(Ansprechpartner siehe Seite 141)**



**Beispiel einer kompakten Shoplösung, bestehend aus einem Mittelraumaufsteller und zwei Kopfgondeln.**

# Werbemittel



Beispiel einer kompakten Shopplösung, Markenpräsentation im aktuellen Design

Werbemittel



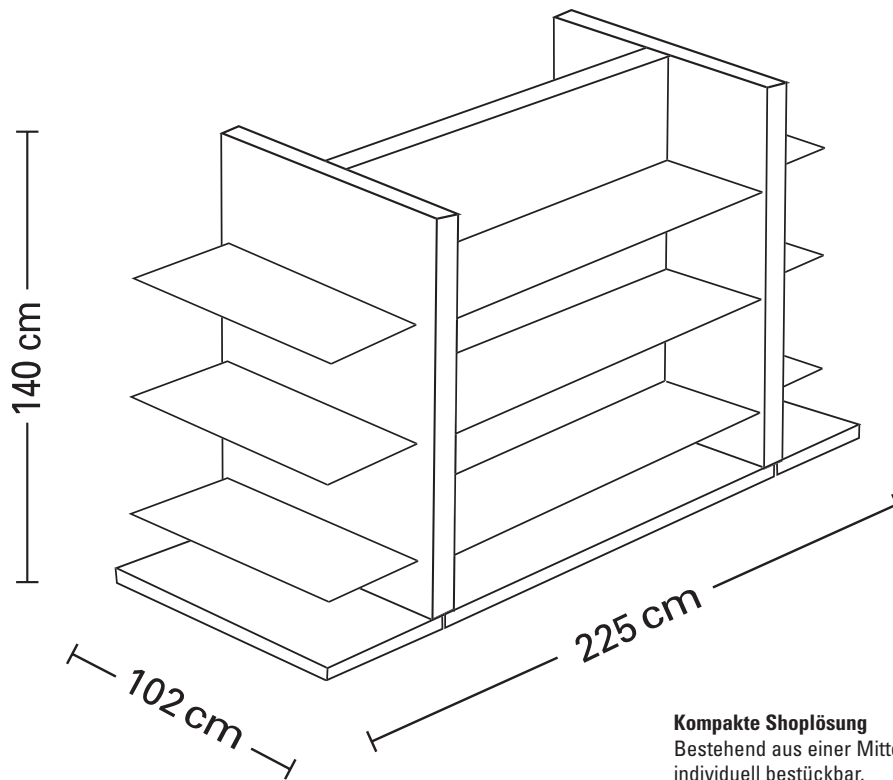

### Kompakte Shoplösung

Bestehend aus einer Mittelraumgondel und zwei Kopfgondeln, individuell bestückbar.  
Mit drei Logos

Maße gesamt: B: 2250 mm, T: 1020 mm, H: 1400 mm

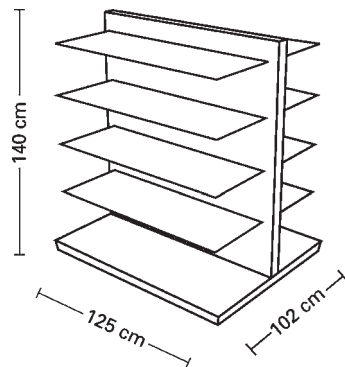

### Mittelraumgondel ohne Beleuchtung

Maße: B: 1250 mm, T: 1020 mm, H: 1400 mm  
Maße der Glasscheiben: 1170 x 400 mm

Grundelement mit Logo

Bestückung Variante 1: 3 Glasböden + 3 Hakenleisten (je 10 Haken)

Bestückung Variante 2: 6 Glasböden

**Wert: 680,00 €**

Optional mit Beleuchtung (4 Leuchtstoffröhren à 21 Watt)

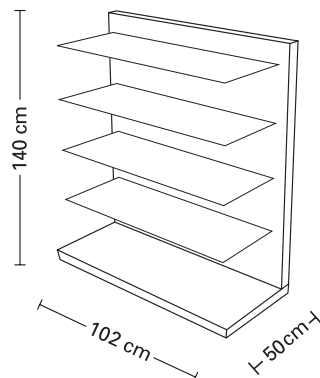

### Kopfgondel ohne Beleuchtung

Maße: B: 1020 mm, T: 500 mm, H: 1400 mm  
Maße der Glasscheiben: 940 x 400 mm

Grundelement mit Logo

Bestückung Variante 1: 3 Glasböden

Bestückung Variante 2: 3 Hakenleisten mit je 10 Haken

**Wert: 480,00 €**

Optional mit Beleuchtung (4 Leuchtstoffröhren à 21 Watt)



GP = Produkt in farbigem Geschenkkarton



KE = auf Karte mit Euroloch

# Werbemittel

## Werbebanner



L/H cm	Art.-Nr.	EAN
40,0 x 112,0 Guss	00 2130 00 00	4 007371 053020
40,0 x 112,0 Porzellan	00 2120 00 00	4 007371 053013
40,0 x 112,0 Pasta	00 2110 00 00	4 007371 053006
40,0 x 112,0 Spargel	00 2140 00 00	4 007371 053037
40,0 x 112,0 Grillen	00 2150 00 00	4 007371 053044

einseitig bedruckt, inklusive Posterschiene und Aufhängeösen

## Flyer



L/H cm	Art.-Nr.	EAN
21,0 x 10,0 Provence	00 1905 00 01	4 007371 060448
7,5 x 22,5 Dekorierlöffel	00 1960 00 00	4 007371 059435
10,0 x 21,0 Pizza/Pasta	00 2110 00 02	4 007371 061131
10,0 x 21,0 Tee	00 1970 00 00	4 007371 060998
10,0 x 21,0 Reiben	00 2160 00 01	4 007371 053501

## Acrylglasblock



B/H/T cm	inch	Art.-Nr.	EAN
15,0 x 6,5 x 2,0	6 x 2½ x ¾	00 0110 00 00	4 007371 060936

## Einkaufstasche Stoff



B/H/T cm	inch	Art.-Nr.	EAN
35,0 x 45,0 x 16,0	13¾ x 17¾ x 6¾	00 1001 00 00	4 007371 031349

## Acrylaufsteller



B/H/T cm	inch	Art.-Nr.	EAN
11,0 x 20,0 x 7,5	4¼ x 7¾ x 3	00 0111 00 00	4 007371 030250



## sales representatives

### Austria

Josef Senn  
Schmiedgasse 7  
A-6020 Innsbruck  
Tel.: +43 512 342 040  
Fax: +43 512 342 041  
Mobil: +43 664 3 001 176  
e-mail: info@agentur-senn.at

### Belgium

Jean-Luc Badin  
6, rue G. Hautmont  
B-7130 Binche  
Tel.: +32 64 336 481  
Fax: +32 64 336 481  
e-mail: jlbadin@skynet.be

### France

Pascal Glorieux  
Glop Studio  
11 rue Fénelon  
F-75010 Paris  
Tel.: +33 1 42 812 489  
Mobil: +33 680 622 863  
e-mail: contact@glopstudio.fr

### Luxembourg

Christian Schnarrenberger  
Weckshof 11  
D-42657 Solingen  
Tel.: +49 212 2 256 782  
Fax: +49 212 22 579 984  
e-mail: ch.schnarrenberger@web.de

### Netherlands

A.G. Kessler & Zn. v.o.f.  
Vermogenweg 209  
NL-3641 ST Mijdrecht  
Tel.: +31 297 250 561  
Fax: +31 297 284 837  
e-mail: info@kessler.nl  
www.kessler.nl

## our partners

### Argentina

Representaciones Albis S.A. de C.V.  
Av. Hermanos Serdan No. 689-A  
col. San Rafael Poniente  
C.P. 72029 Puebla, Pue  
Tel.: +52 1 228 915 731  
Fax: +52 1 8 002 110 406  
info@albis.com.mx

### Bulgaria

SIA ltd.  
Zona B-5; bl. 18, ap. 9  
BG-1303 Sofia  
Tel.: +359 2 9206 217  
Fax: +359 2 920 291  
office@siabg.net

### Columbia

Ambientes Accesorios S.A.  
Calle 66 No. 20-15  
Bogota  
Tel.: +571 248 1 655  
Fax: +571 215 9 930  
carmina.villegas@carminavillegas.com

### Cyprus

Parousiasi Ltd.  
L Arh.Makariou C & Z Souza  
1075 Lefkosia/Nicosia  
Tel.: +30210 9 478 130  
Fax: +30210 9 415 002  
dnasi@sarafidisgroup.gr

### Czech Republic

Mobax CR s.r.o.  
Suchdolska 782  
CZ-25358 Horomerice  
Tel.: +420 233 920 408  
Fax: +420 233 920 411  
mobax@mobaz.cz

### Finland

Decanter Oy Ltd  
Melkonkatu 24  
FI -00210 Helsinki  
Tel.: +358 505 771 306  
Fax: +358 9 68 604 127  
decanter@decanter.fi

### Great Britain

Gilberts Food Equipment Limited  
1 Warwick Place, Warwick Road  
Borehamwood, Herts WD6 1UA / GB  
Tel.: +44 20 87 313 700  
Fax: +44 20 87 313 737  
info@gilberts-foodequipment.co.uk

### Greece

Cook-Shop Chain  
Berson/ C. Sarafidis Bros. S.A.  
GR-17675 Kalithea – Athen  
Tel.: +30 2310 9 928 472  
Fax: +30 2310 9 32 115  
cookshop@sarafidisgroup.gr

### Israel

Malys H & M Ltd.  
3 Hasadna st. Industrial Area  
58814 Hulon  
Tel.: +972 3 5 502 996  
Fax: +972 3 5 501 107  
haim@malys.co.il

### Italy

Schönhuber SpA  
Via J.G. Mahl 52  
I-39031 Brunico  
Tel.: +39 0474 571 000  
Fax: +39 0474 571 099  
info@schoenhuber.com

### Korea

Peniel Ind. Co., Ltd.  
699 Yulseek-ri, Wabu-eup,  
Namyangju-City  
Tel.: +82 31 5 766 848  
Fax: +82 31 5 766 849  
philip7@elcuizen.com

### Jordan

Irfan Tading Stores  
Al-Sveifia, Yacoub Muammar Str. 7  
P.O. Box 5560  
Amman  
Tel.: +962 06 5 811 170  
Fax: +962 06 5 821 200  
info@irfanjo.com

### Mexico

Representaciones Albis, S.A. de C.V.  
Blvd. Hermanos Serdán No. 689 A  
Col. San Rafael Poniente  
C.P. 72029 Puebla, Pue.  
Tel.: +52 222 8 915 731  
Fax: +52 222 8 915 733  
info@albis.com.mx

### Norway

Matec Maskiner AS  
Welhavensvei 1  
N-4319 Sandnes  
Tel.: +47 51 526 580  
Fax: +47 51 528 498  
jone@matec.no  
www.matec.no

### Peru

Viewcorp S.A.C.  
Av.Pardo y Aliaga 699-303B  
27 San Isidro, Lima  
Tel.: +51 1 4 412 567  
Fax: +51 1 4 214 377  
ron@viewcorp-trading.com

### Poland

FreeForm  
Ul. Kobialka 60  
03-044 Warschau  
Tel.: +48 225 199 380  
Fax: +48 225 199 381  
janusz@freeform.com.pl

### Portugal

Lobena Lda.  
Rua das Pedreiras, 345  
Zona Ind. Sao Caetano  
Vilar do Paraíso  
P-4405-587 Vila Nova de Gaia  
Tel.: +351 227 115 821  
+351 227 115 579  
Fax: +351 227 115 861  
lobena@lobena.pt

### Russia

MSW Aussenhandel  
Annette-Kolb-Weg 1  
D-65462 Ginsheim  
Tel.: +49 6144 334 131  
Fax: +49 6144 334 133  
msw.gin@googlemail.com

### Slovenia

RUBICO TRADE D.O.O.  
Smrekarjeva 1  
3000 Celje  
tel: 03 490 7002  
fax: 03 541 3001  
mateja.percic@rubico-trade.si

### South Africa

Third Avenue Trading C.C.  
PO Box 3214  
2121 Parklands  
Tel.: + 27 11 2 662 379  
Fax: + 27 11 3 271 131  
tat1@hvi.co.za

### Spain

Guitarte Distribuciones, S.L.  
Pol.Ind.Mallolas, Masias de Roda, 10  
ES-08500 Vic  
Tel.: +34 93 8 891 338  
Fax: +34 93 8 814 685  
albert@guitarte.com

### Sweden

Berg & Nycander AB  
Box 107  
S-17822 Ekeröe  
Tel.: +46 8 56 031 070  
Fax: +46 8 56 031 565  
caroline@bony.se

### Switzerland

Mayer & Bosshardt AG  
Riehenring 175/2. Stock  
CH-4058 Basel  
Tel.: +41 61 6 909 730  
Fax: +41 61 6 909 731  
bosshardt@mbag.ch

### United Arab Emirates

4 Homes FZ Co.  
P.O. Box 62688  
Dubai  
Tel.: +971 4 8 813 383  
Fax: +971 4 8 817 393  
nazia@4homes.ae

### Uruguay

Impex International S.A.  
Marcelino Sosa 2326  
11800 Montevideo  
Tel.: +598 2 2 082 972  
impex@redfacil.com.uy

### USA

Frieling  
398 York Southern Rd  
Fort Mill, SC 29715-7715  
T: 803-548-2000  
F: 803-548-2060  
mfs@frieling.com  
www.frieling.com



# Kontakt / contact

## KÜCHENPROFI GmbH

42699 Solingen · Höhscheider Weg 29  
42669 Solingen · Postfach 110925

Telefon: +49 (0) 212 / 65 82 - 0

Fax: +49 (0) 212 / 65 82 - 33 (Verkauf Inland)  
+49 (0) 212 / 65 82 - 26 (Verkauf Export)

Internet: [www.kuechenprofi.de](http://www.kuechenprofi.de)

e-mail Verkauf Inland: [verkauf@kuechenprofi.de](mailto:verkauf@kuechenprofi.de)

e-mail Verkauf Export: [export@kuechenprofi.de](mailto:export@kuechenprofi.de)

### Geschäftsführer

Willy E. Schnarrenberger  
Stefan Schmitz

### Verkaufsleitung

Klaus Merten

### Key Account

Werner Spedale  
Kordula Schmidt

### Export

Claudia Kaldasch

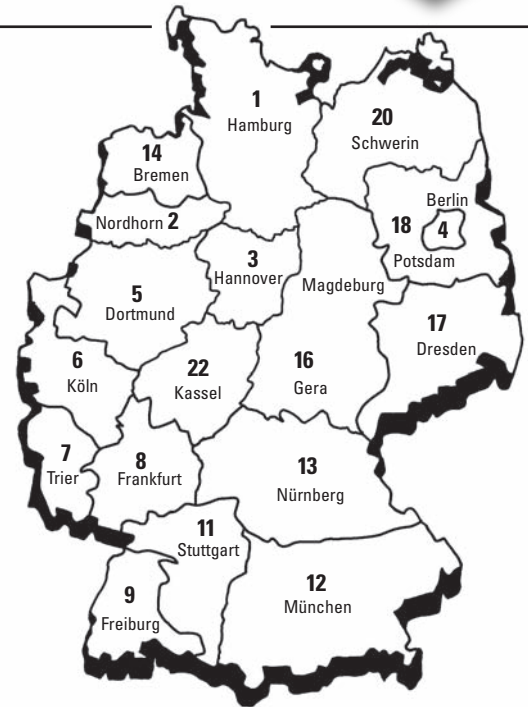

**1** Hamburg, Schleswig-Holstein, Bremen,

**2** Norbert Jester

Rahnstraße 25  
D-22179 Hamburg

Telefon: 0 40 / 6 420 139

Telefax: 0 40 / 6 415 530

Mobil: 0 172 / 4 118 509

e-mail: [n.jester@kuechenprofi.de](mailto:n.jester@kuechenprofi.de)

**14**

**6** Niederrhein, Kölner Bucht, Eifel, Siegtal,  
Bergisches Land, PLZ-Gebiet 56, Luxemburg

**24** Christian Schnarrenberger

Weckshof 11  
D-42657 Solingen

Telefon: 0 212 / 2 256 782

Telefax: 0 212 / 22 579 984

Mobil: 0 176 / 22 883 426

e-mail: [ch.schnarrenberger@kuechenprofi.de](mailto:ch.schnarrenberger@kuechenprofi.de)

**24**

**12** Bayern, Franken

**13** Manfred Weißenberg

Buchgasse 7  
D-92715 Püchersreuth

Telefon: 09 602 / 37 112

Telefax: 09 602 / 37 112

Mobil: 0 151 / 14 123 117

e-mail: [m.weissenberg@kuechenprofi.de](mailto:m.weissenberg@kuechenprofi.de)

**13**

**3** Westfalen, Hannover,  
westliches & östliches Niedersachsen

**5** Stefan Herkströter

Overhove 2  
D-33803 Steinhagen

Telefon: 05 204 / 80 709

Telefax: 05 204 / 80 397

Mobil: 0 172 / 5 322 316

e-mail: [s.herkstroeter@kuechenprofi.de](mailto:s.herkstroeter@kuechenprofi.de)

**5**

**7** Saarland, Hessen,  
Rheinland-Pfalz,

**8** südl. Nordrhein-Westfalen

**22** Klaus Katzmarzik

Burgstraße 9  
D-35444 Biebertal

Telefon: 06 409 / 804 770

Telefax: 06 409 / 804 769

Mobil: 0 172 / 2 662 511

e-mail: [k.katzmarzik@kuechenprofi.de](mailto:k.katzmarzik@kuechenprofi.de)

**22**

**16** Thüringen,  
Sachsen, Sachsen-Anhalt

**17** Marko Heim

Untere Hauptstraße 29  
D-09244 Lichtenau b. Chemnitz

Telefon: 037 208 / 88 898

Telefax: 037 208 / 88 897

Mobil: 0 177 / 2 341 956

e-mail: [m.heim@kuechenprofi.de](mailto:m.heim@kuechenprofi.de)

**17**

**4** Berlin, Brandenburg, Sachsen-Anhalt

**18** Bernhard Zawadzki

Mühlenstraße 6  
34346 Hannoversch-Münden

Telefon: 05 541 / 955 872

Telefax: 05 541 / 955 757

Mobil: 0 178 / 8 080 560

e-mail: [b.zawadzki@kuechenprofi.de](mailto:b.zawadzki@kuechenprofi.de)

**18**

**9** Baden-Württemberg

**11** Andreas Pritzl

Heilig-Brünne-Str. 82/1  
D-72461 Albstadt-Truchelfingen

Telefon: 07 432 / 9 840 490

Telefax: 07 432 / 9 840 492

Mobil: 0 172 / 6 234 873

e-mail: [a.pritzl@kuechenprofi.de](mailto:a.pritzl@kuechenprofi.de)

**11**

**20** Mecklenburg-Vorpommern

Carl Peter Fosseck

Thorkoppel 1  
D-22885 Barsbüttel

Telefon: 040 / 6 701 537

Telefax: 040 / 6 704 049

Mobil: 0 173 / 2 708 155

**20**

**Für Bestellungen gelten unsere in der Preisliste aufgeführten Allgemeinen Geschäftsbedingungen.**

**Änderungen im Sortiment behalten wir uns vor.**

# index

<b>A</b>		
all-purpose tongs	93	
anti splash sieve	43	
apple corer	47, 98	
apple divider	47	
apron for children	38	
asparagus peeler	60	
asparagus pot	60	
asparagus tongs	48	
attachment for pasta machine	23, 24	
<b>B</b>		
bain marie pot	121	
baking beans	37	
baster set	76	
BBQ basket	89, 91	
BBQ brush	95	
BBQ gloves	93	
BBQ pan	91	
BBQ set	95	
BBQ skewers	92	
BBQ tongs	93	
BBQ tongs for fish	89	
board	126, 127	
bowl	121	
braising pot	6, 8, 9	
bread box	40	
breeding set	42	
breakfast board	126	
butter dish	46	
butter melter	121	
<b>C</b>		
cake lifter	38	
cake pop set	32	
cake ring	35	
cake thermometer	38	
can opener	98, 110	
candy thermometer	50	
ceramic hob cleaner	109	
cheese cutter	100	
cheese fondue casserole	114	
cheese grater	69, 109	
cheese knife	97	
cheese plane	98	
chicken leg holder	90	
chicken roast rack	90	
chili mill	134	
chocolate set	32	
closing clips	109	
coffee maker	84	
colanders	43, 122	
confectionery funnel	31	
cookie cutter	33	
cookie stamp	33	
cooking spoon holder	53	
cooking tweezers	93	
cooling rack	35	
cord box	75	
corn holder	92	
Crème Brûlée dish	15, 118	
Crème Brûlée set	118	
Crème Brûlée torch	118	
crinkle cutter	47	
cucumber slicer	63, 68	
cup cake mould	34	
cutting board	126, 127	
decorating rings	44	
<b>D</b>		
decorating set	31, 34	
decorating squeeze bottle	34	
decoration cutter	45	
deep baker	13, 16, 17	
deep fry thermometer	77	
dessert rings	44	
dessert server	98	
dish draining rack	87	
dish washing brush	86, 101	
double boiler	121	
double slicer	63	
dredger	56, 131	
dressing shaker	109	
dryer balls	86	
<b>E</b>		
egg beater	109	
egg cup	14	
egg lifter	100	
egg pricker	108	
egg ring	86	
egg separator	108	
egg shell topper	108	
egg slicer	108	
<b>F</b>		
fat separator jug	76	
finger protector	68	
fish / asparagus tongs	48	
fish scaler	48	
fishbone tweezers	48	
flan dish	14, 19, 36	
flat colander	43	
flavour grater	47	
flour sieve	37	
foam cup	84	
fondue forks	115	
fondue plate	114	
fondue set	115	
fondue spoon	114	
food mill	51	
french oven	6, 9	
fry pan	7, 10	
fuel paste	114	
funnel	50	
<b>G</b>		
garlic peeler	104	
garlic plane	104	
garlic press	104	
garnishing injection	34	
garnishing spoon	30	
gas torch	118	
gourmet marinade injector	76	
gourmet set	32	
gourmet skewers	75	
grater	62, 64 - 68	
grill board	91	
grill pan	7, 10	
<b>H</b>		
hamburger grilling basket	94	
hamburger press	94	
hamburger turner	94	
hand guard	64 - 66	
herb canister	56	
herb scissors	124, 125	
hourglass	73	
<b>I</b>		
icecream scoop	86	
icing bag	34	
icing set	31	
icing spatula set	35	
<b>J</b>		
jacket potato fork	46	
jam funnel	50	
jar and bottle opener	110	
julienne cutter	47	
<b>K</b>		
kitchen scales	41	
kitchen scissors	124, 125	
larding needle	75	
<b>L</b>		
lasagna pan	120	
lemon squeezer	15, 110	
lemon zester	97	
lid for lasagna/roasting pan	120	
linzer cookie cutter	33	
lobster forks	87	
lobster tongs	87	
lunchbox	53	
<b>M</b>		
macaron set	32	
magnetic knife rack	101	
marinade set	91	
measuring cup	37	
meat clamp	75	

## index

meat cleaver	42	potato masher	99, 101	steaming insert	86
meat fork	99	potato press	105	strainer	102
meat grinder	37	potato rack	90		
meat pounder	42	poultry scissors	46, 124	<b>T</b>	
meat press	94	pour off sieve	43	tarte flambée paddle	28
melon baller	97	pudding bowl	14	tartlets set	31, 32
microwave dish	13	pudding mould	35	tea / spice tongs	80
milk frother	84			tea bag clips	81
mincing knife	58	<b>Q</b>		tea bag holder	81
mini casserole	11	quiche pan	36	tea bag tongs	80
mini pot	121			tea ball	80, 81
mixing bowl	121, 122	<b>R</b>		tea glasses	82
mortar	57	raclette	112	tea pot	82, 83
motor for pasta machine	23	raclette saucer	112	tea strainer	80, 81, 102
multi chopper	106	raclette spatula	113	tea warmer	81
mushroom brush	51	ramekin	14, 15, 18	Teaboy	79
		rasp	67	thermometer	38, 50, 77
<b>N</b>		ravioli cutter	25	timer	71 - 73
nut cracker	84	ravioli mould	25	tomato corer	46
nutmeg grater	56, 68, 97	ravioli stamp	25	tomato slicer	106
nutmeg mill	56	refrigerator thermometer	77	tongs	87, 89, 93
nylon turner	98	ring for fried egg	86	trivet	43
		roast thermometer	77	truffle plane	43, 99
<b>O</b>		roast tongs/holder	110	tureen dish	15
odor absorber	110	roasting pan	7, 10, 120	tureen mould	45
oil dispenser	58	rolling pin	37	turner	99
olive oil sprayer	58	roulade needles	75	turning fork	48
oven gloves	76, 93	roulade rings	75		
oven mitt	76			<b>U</b>	
oven thermometer	77	<b>S</b>		utensil rack	100
oyster glove	87	salad spinner	107, 108		
oyster knife	97	salt	131	<b>V</b>	
		salt mill	132 - 135	vegetable brush	51
<b>P</b>		sandglass	73	vegetable peeler	58, 60
paella pan	8, 10	sauce ladle	99	vegetable slicer	63
palette	98	saucepan	60, 121	vinegar sprayer	58
palette knife	97	scales	41		
paper towel holder	54	scissors	124, 125	<b>W</b>	
parsley/herb mill	106	serving spoon	99	warmer for saucepan	60
pasta drying stand	24	serving tongs	48	whisk	100, 101
pasta machine	21, 22, 24	s-hook	100	wok set	8, 10
pasta pot	120	sieve	43, 51, 102		
pastry cutter	97	skewers	75	<b>Z</b>	
pastry scraper	37, 38	skimmer	26, 99	zester	65 - 67, 97
pastry spoon set	31	soap, stainless steel	104		
peeler	98	soup ladle	99		
pepper	131	spaetzle lid	26		
pepper mill	131 - 135	spaetzle maker	26		
pie dish	15	spaetzle plane	26		
pineapple slicer	106	spaetzle press	105		
pizza cutter	28, 97	spaghetti measure	25		
pizza paddle	28	spaghetti server	100		
pizza server	38	spice ball	81		
pizza stone	28	spice grater	68		
plate warmer	116	spice rack	129, 130		
pot set	120	spiral cutter	47		
potato / spaetzle press	26	spoon holder	53		
potato cutter	105	spoon rest	53		
potato grater	63	springform pan	36		



# Inhalt

<b>A</b>		<b>E</b>		<b>H</b>	
Abgieß-Sieb	43	Eierbecher	14	Hähnchengriller	90
Abtropfgestell	87	Eierköpfer	108	Hamburger-Grillzange	94
Allzweckzange	93	Eierschneider	108	Hamburger-Presser	94
Ananasschneider	106	Eieruhr	73	Hamburger-Wender	94
Apfelausstecher	98	Eierwender	37, 100	Haushaltsschere	124
Apfelteiler	47	Eipicker	108	Hummergabeln	87
Aromabräter	120	Eisportionierer	86	Hummerzange	87
Aromareibe	47	Ei-Trenner	108		
Auflaufform	13, 16	Espressokocher	84	<b>J</b>	
Aufsatz für Nudelmaschine	23, 24	Essig-Sprüher	58	Julieneschneider	47
Aufschäumbecher	84			Julienne-Set	47
Ausstecher	33	<b>F</b>		<b>K</b>	
Austernbrecher	97	Fett-Trennkanne	76	Kartoffel-/Spätzlepresse	26
Austernhandschuh	87	Finger-Schneidschutz	68	Kartoffelpresse	105
		Fisch-/Spargelzange	48	Kartoffelreibe	63
<b>B</b>		Fischentschupper	48	Kartoffelstampfer	99, 101
Backofen-Thermometer	77	Fischgräten-Pinzette	48	Käsehobel	98
Bauernform	13	Fischgrillzange	89	Käsemesser	97
Bauernpfanne mit Glasdeckel	6, 9	Flammkuchenbrett	28	Käsereibe	69, 109
Bayrischer Bräter	120	Fleischbeschwerer	94	Käseschneider	100
BBQ-Set	95	Fleischgabel	99	Keks-Stempel	33
Blindbackkugeln	37	Fleischklopper	42	Kinderschürze	38
Brat-/Grillzange	93	Fleischwolf	37	Knoblauchpresse	104
Brat-/Wendepinzette	93	Fondant-Trichter	31	Knoblauchschäler	104
Braten-/Gewürzspritze	76	Fonduegabeln	115	Knoblauchschneider	104
Bratenthermometer	77	Fondue-Set	115	Kochlöffelständer	53
Bratentopf mit Gussdeckel	6, 9	Fondueteller	114	Kombi-Thermometer	77
Bratenzange / Schneidehilfe	110	Frittierthermometer	77	Kompaktseife	104
Bratpfanne	7, 10	Frühstücksbrett	126	Konditormesser-Set	35
Bratreine	7, 10, 120			Kordelbox	75
Brennpaste	114	<b>G</b>		Kräuterschere	124, 125
Brett	126, 127	Garnierspritze	34	Küchenbeil	42
Brotkästen	40	Gasbrenner	118	Kuchengitter	35
Brühsieb	122	Geflügelschere	46, 124	Kuchenretter/Pizzaheber	38
Butterdose	46	Gemüsebürste	51	Küchenschere	124, 125
Butterpfännchen	60, 121	Gemüsehobel	63	Küchensieb	102
		Gemüseschäler	58, 60	Kuchenthermometer	38
<b>C</b>		Gemüsesehier	122	Küchenwaage	41
Caquelon	114	Gestell für Hühnerschenkel	90	Kühlschrank-Butterdose	46
Champignonbürste	51	Gewürz-/Marinadenspritze	76	Kühlschrank-Geruchskiller	110
Chilimühle	134	Gewürzgläser	56	Kühlschrank-Thermometer	77
Crème Brûlée - Brenner	118	Gewürzkugel	81		
Crème Brûlée - Schale	15, 118	Gewürzreibe	68	<b>L</b>	
Crème Brûlée - Set	118	Gewürzständer	129, 130	Lasagneform	13, 17
		Glaskeramik-Reiniger	109	Linzer-Ausstecher	33
<b>D</b>		Gourmethobel	99	Löffelablage	53
Dämpfeinsatz	86	Gourmetpfanne	6, 8, 9	Lunchbox	53
Deckel zu Bayrischem Bräter	120	Gourmet-Set	32		
Dekorier-/Garnier-Set	34	Gourmetspieße	75	<b>M</b>	
Dekorierflasche	34	Grillbretter	91	Macaron-Set	32
Dekorierlöffel	30	Grillbürste	95	Magnetleiste	101
Dekorierschneider	45	Grillgemüse-Korb	89	Maiskolbenhalter	92
Dekorier-Set	31	Grillhandschuhe	93	Marinaden-Set	91
Dessert-/Vorspeisenringe	44	Grillkartoffel-Halter	90	Marmeladentrichter	50
Dessertportionierer	98	Grillkorb	91	Meersalz	131
Dosenöffner	98, 110	Grillpfanne	7, 10, 91	Mehlsieb	37
Dressingshaker	109	Grillspieße	92	Melonenausstecher	97
		Grillzange	93		
		Gurkenhobel	63, 68		

# Inhalt

Messbecher	37	Rechaud für Butterpfännchen	60	Tartelett-Set	31, 32
Mikrowellenform	13	Reiben	62, 64 - 68	Teaboy	79
Milchaufschäumer	84	Restehalter	64 - 66	Tee-/Gewürzkugel	80, 81
Mini-Töpfchen	11, 121	Rettichschneider	47	Tee-/Gewürzzange	80
Mörser	57	Rouladenklammern	75	Teebeutel-Halter	81
Motor für Nudelmaschine	23	Rouladennadeln	75	Teebeutel-Klammer	81
Muffin-Form	34	Rouladenringe	75	Teebeutel-Zange	80
Multibräter	120	Rührlöffel-Set	31	Teefilter	80
Multischneider	106	Rührschüssel	121	Teegläser	82
Multizange	93	Rundschüssel	122	Teekanne	82, 83
Muskatmühle	56			Teesieb	80, 81, 102
Muskatreibe	56, 68, 97			Teigrädchen	97
		<b>S</b>		Teigrolle	37
		Salatschleuder	107, 108	Teigschaber	37, 38
		Salzmühlen	132 - 135	Tellerwärmer	116
		Sanduhr	73	Terrinenform	15, 45
		Saucenlöffel	99	Thermometer	38, 50, 77
		Schaumlöffel	26, 99	Timer	71 - 73
		Scheren	124, 125	Tomatenschneider	106
		Schlemmerform	13	Tomatenstrunkentferner	46
		Schneebesens	100, 101	Topfhandschuh	76
		Schneeschläger	109	Topf-Set	120
		Schneidebrett	126, 127	Tortelettförmchen	14
		Schöpflöffel	99	Tortenform	14, 19
		Schüssel	121, 122	Tortenring	35
		Seiher	122	Trichter	50
		Servierlöffel	99	Trocknerbälle	86
		Servierzange	48	Trüffelhobel	43
		Setzei-Ring	86	Türkisch Mocca-Becher	84
		S-Haken	100		
		Siebe	43, 102		
		Siebeinsatz	43	<b>U</b>	
		Siedelöffel	114	Universalöffner	110
		Silikon-Teigschaber	37	Untersetzer	43
		Spaghettiheber	100		
		Spaghetti-Maß	25	<b>V</b>	
		Spargelkocher	60	Verschlussklammern	109
		Spargelschäler	60	Vorspeisenringe	44
		Spargelzange	48		
		Sparschäler	98	<b>W</b>	
		Spätzle-Ass	26	Waage	41
		Spätzle-Hobel	26	Wandküchenleiste	100
		Spätzlepresse	105	Wasserbad-Topf	121
		Spätzlereibe	26	Wellenschneider	47
		Spicknadel	75	Wendegabel	48
		Spieße	75, 92	Wender	99
		Spiralschneider	47	Wiegemesser	58
		Spitzsieb	102	Wok-Set	8, 10
		Springform	36		
		Spritzbeutel-/Dekorier-Set	34	<b>Z</b>	
		Spritzbeutel-Set	31	Zange	87, 89, 93
		Spritzschutzsieb	43	Zester	65 - 67, 97
		Spülbürste	86, 101	Zitronenpresse	15, 110
		Stempel für Kekse	33	Zitronenzester	97
		Stielkasserolle	121	Zuckerthermometer	50
		Stövchen	81	Zweifachhobel	63
		Streuer	56, 131		
		<b>T</b>			
		Tarte- und Quicheform	36		
		Tartelettform	36		
<b>N</b>					
Nudelmaschine	21, 22, 24				
Nudeltrockner	24				
Nussknacker	84				
Nylonwender	98				
<b>O</b>					
Ofenhandschuhe	76, 93				
Olivenöl-Sprüher	58				
Öl-Spender	58				
<b>P</b>					
Paellapfanne	8, 10				
Palette	98				
Palettenmesser	97				
Panier-Set	42				
Papierrollenhalter	54				
Passiergerät	51				
Passiersieb	51, 122				
Pastatopf	120				
Pastetenform	15				
Pellkartoffel-Set	46				
Petersilien-/Kräutermühle	106				
Pfannen-/Wendegabel	48				
Pfeffer	131				
Pfeffermühlen	131 - 135				
Pizzaheber	38				
Pizza-Schieber	28				
Pizzaschneider	28, 97				
Pizza-Stein	28				
Plätzchen-Ausstecher	33				
Pommes Frites-Schneider	105				
Popcake-Set	32				
Pralinen-Set	32				
Puddingform	14, 35				
<b>R</b>					
Raclette	112				
Raclette-Brettchen	112				
Raclette-Schaber	113				
Ragoutschälchen	14, 15, 18				
Raspel	67				
Ravioliausstecher	25				
Raviolibrett	25				
Ravioli-Former	25				
Ravioli-Rad	25				



KÜCHENPROFI GmbH  
42699 Solingen · Höhscheider Weg 29  
42669 Solingen · Postfach 110925

Tel.: +49 (0) 212/6582-0  
Fax: +49 (0) 212/6582-10/-33

e-mail: [verkauf@kuechenprofi.de](mailto:verkauf@kuechenprofi.de)  
Internet: [www.kuechenprofi.de](http://www.kuechenprofi.de)

GERMANY

© KÜCHENPROFI  
Katalog 2015 3/15/7500/0149 ME  
Art.-Nr. 00.1002 00 00